

# Comfort Control Retrofit

## Instructions

**Kits: 20301078, 20101079**

## Convert to SIT HI/LOW Control

The parts in this kit are intended to replace the Honeywell Comfort Control gas and ignition control system in the following fireplace models:

DV360RF(N,P), DV580RF(N,P), DVRT36RF(N,P),  
DVB4136RF(N,P).

### CAUTION

Before installing this conversion kit:

- Disconnect electrical power to fireplace.
- Shut off gas supply.
- Shut off gas control valve.
- Allow unit to cool completely.
- Unplug fan cord from electrical outlet.

### Kit contents:

SIT Gas Valve w/ Stepper Motor  
L-Bracket, Valve, #10007342 (for DV580 only)  
Ignitor, Piezo, #057958  
Bracket, Ignitor, #52533  
Konb Extension, #43D0094  
Pilot Assembly  
20308624, 20308625, 20308626 (transmitter, receiver  
assy, batteries, wire harnesses, hardware)

**Tools required:** Adjustable Wrenches (2), Phillips  
Screwdriver, Robertson Screwdriver, High Temperature  
Silicone Sealant, Pipe Thread Sealant

This kit is to be installed only by a qualified service person familiar with the control system in accordance with these manufacturer's instructions and all applicable codes and requirements of the authority having jurisdiction. If the information in these instructions is not followed exactly, a fire, explosion or production of carbon monoxide may result causing property damage, personal injury or loss of life. The installation is not proper and complete until operation of the converted appliance is checked as specified in these manufacturer's instructions supplied with this kit.

## Procedure

Remove glass door and all logs. Be sure to note the location of each log or refer to fireplace Homeowner's Manual.

**NOTE:** It is recommended but not required that the burner tray be removed to complete this conversion. Disconnect the inlet fittings and remove the burner tray from the fireplace if possible.

### Removal of Honeywell System Components:

1. Disconnect fuel supply line fittings from valve inlet fittings.
2. Disconnect manifold tube fitting from valve outlet fittings.
3. Disconnect pilot supply tube fitting from valve.
4. Disconnect all four (4) pilot assembly wires from valve.
5. Disconnect power cord from fan and valve. Discard cord.
6. Disassemble and remove valve from valve bracket. Remove inlet and outlet fittings from valve and clean threads for re-use. Discard valve and mounting screws.
7. For Models DV580RF only: Remove valve bracket from fireplace and discard.
8. Loosen or remove silicone sealant around pilot tube and wiring where they pass through fireplace floor.
9. Disassemble and remove from fireplace the pilot assembly, pilot fuel line and pilot wiring and discard all.

### Installation of SIT System Components

1. Install new pilot to fireplace pilot bracket. Route tubing and wiring through fireplace floor. Reseal with silicone sealant around where tubing and wiring pass through fireplace floor.
2. Install new valve bracket (if removed). Refer to Figures 1 for correct bracket.
3. Apply pipe thread sealant and install brass fittings into SIT valve inlet and outlet.

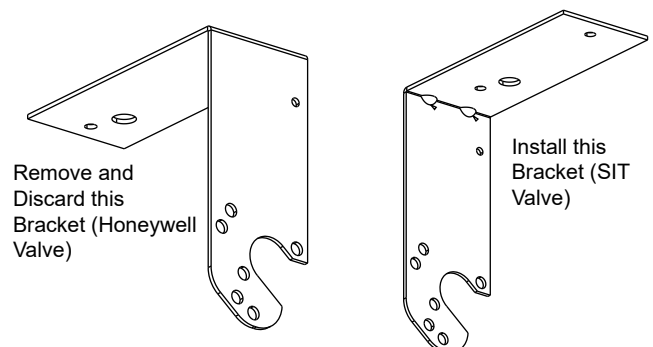

**Fig. 1** DV580 Valve Bracket

4. Install gas valve to bracket. **IMPORTANT: Make sure the gas valve is oriented properly. The valve outlet is on the same side as the terminal block.** Figure 2

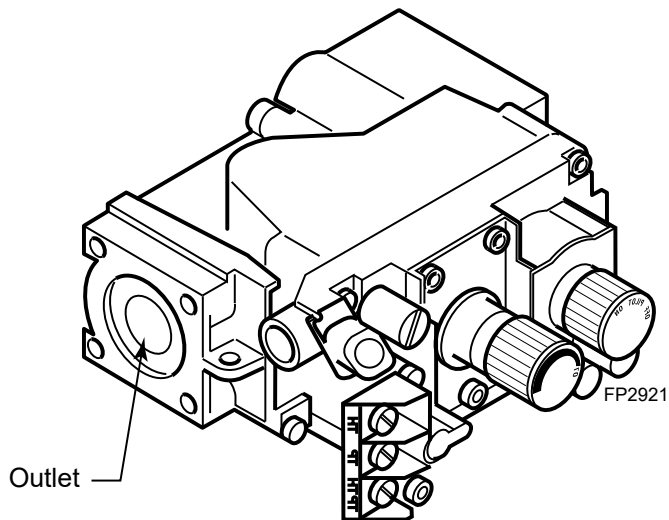

**Fig. 2** SIT Valve

5. Assemble manifold tube fitting to valve outlet fitting. Tighten securely.
6. Assemble fuel supply line fitting to valve inlet fitting. Tighten securely.
7. Assemble pilot fuel supply tube fitting to valve. Tighten fitting securely. Do not overtighten.
8. Assemble pilot thermocouple fitting to valve. Tighten fitting securely. Do not overtighten.
9. Connect pilot thermopile wire terminals to valve terminals TP and TP/TH.

10. Locate supplied ignitor bracket. The bracket mounts to the right front of valve. Determine whether bracket should be mounted with either an upward or downward angle depending on the clearance available in your fireplace model.
11. Remove nut from supplied piezo ignitor.
12. Install piezo ignitor to bracket using nut provided. Do not overtighten.
13. Attach wire from pilot spark electrode firmly onto push-on terminal at rear tip of piezo ignitor.
14. Attach ignitor and bracket to the right side of the valve using screw provided.

**For Bayfront Models ONLY:** Attach extension knob onto valve ON/OFF knob.

15. To complete assembly of remaining components, refer to assembly instructions and warnings provided with Remote Receiver 20308624 and Transmitter 20308625.
16. Apply the supplied Velcro strip to the bottom of the receiver box and attach box to a convenient location near the front of the fireplace floor.
17. Reinstall burner, embers and pilot shield (if removed) and logs. Refer to fireplace Homeowner's Manual for proper log placement.

### Leak Test

1. Turn fuel shut-off valve to ON.
2. Light pilot according to instructions provided.
3. Using a soap and water solution, check for and repair any detected leaks.

Refer to separate instructions provided with the Transmitter 20308625 for information on remote control operation and troubleshooting.

# Lighting and Operating Instructions

## FOR YOUR SAFETY READ BEFORE LIGHTING

**WARNING:** If you do not follow these instructions exactly, a fire or explosion may result causing property damage, personal injury or loss of life.

- A. This heater has a pilot which must be lit manually. When lighting the pilot follow these instructions exactly.
- B. BEFORE LIGHTING smell all around the heater area for gas. Be sure to smell next to the floor because some gas is heavier than air and will settle on the floor.

### WHAT TO DO IF YOU SMELL GAS

- Do not try to light any fireplace
  - Do not touch any electric switch
  - Do not use any phone in your building
  - Immediately call your gas supplier from a neighbor's phone. Follow the gas supplier's instructions.
- C. Use only your hand to push in or turn the gas control knob. Never use tools. If the knob will not push in or turn by hand, do not try to repair it, call a qualified service technician. Applying force or any attempted repair may result in a fire or explosion.
  - D. Do not use this fireplace if any part has been under water. Immediately call a qualified service technician to inspect the heater and to replace any part of the control system and any gas control which has been under water.

## Lighting Instructions

1. **STOP!** Read the safety information above.
2. Turn off all electrical power to the fireplace.
3. Open control access panel.
4. Push in gas control knob slightly and turn clockwise  to "OFF".

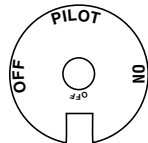

SIT NOVA

5. Wait five (5) minutes to clear out any gas. Then smell for gas, including near the floor. If you smell gas, STOP! Follow "B" in the safety information above. If you do not smell gas, go to the next step.
6. Remove glass door before lighting pilot.
7. Visibly locate pilot by the main burner.
8. Turn knob on gas control counterclockwise  to "PILOT".

9. Push the control knob all the way in and hold. Immediately light the pilot by repeatedly depressing the piezo spark ignitor until a flame appears. Continue to hold the control knob in for about one (1) minute after the pilot is lit. Release knob and it will pop back up. Pilot should remain lit. If it goes out, repeat steps 5 through 8.

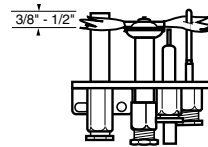

- If knob does not pop up when released, stop and immediately call your service technician or gas supplier.
  - If after several tries, the pilot will not stay lit, turn the gas control knob to "OFF" and call your service technician or gas supplier.
10. Replace glass door.
  11. Turn gas control knob to "ON" position.
  12. Turn on all electrical power to the fireplace.

## To Turn Off Gas To Heater

1. Turn the On/Off switch to Off position or set the thermostat to lowest setting.
2. Turn off all electric power to the fireplace if service is to be performed.
3. Open louvre assembly bottom.
4. Push in gas control knob slightly and turn clockwise  to "OFF". Do not force.
5. Close control access panel.

Hearth & Home Technologies  
7571 215th Street West, Lakeville, MN 5044  
[www.hearthnhome.com](http://www.hearthnhome.com)