



INSTALLATION AND OPERATION GUIDE FOR



RGA 2-72
ANSI Z21.84

HARGROVE GAS LOGS

Ember Burner (EB) & H-Burner (HB)

For model number and PFS seal refer to attached nameplate.

Installation and service must be provided by a qualified installer, service agency or the gas supplier.

NOTE: ADEQUATE FIREPLACE VENTILATION IS REQUIRED FOR SAFETY
READ INSTRUCTIONS FULLY BEFORE INSTALLING OR OPERATING
INSTALLER: LEAVE THESE INSTRUCTIONS WITH CONSUMER!

Hargrove gas logs are made with refractory materials. Each log is hand-finished to assure the most realistic, detailed log available. The gas log burner system is designed to burn like wood, with a smoky flame. For this reason, the gas log set must be burned only in a fully vented, non-combustible fireplace with the **damper completely open** and the chimney free of any obstructions or restrictions. The fireplace must be designed and approved to burn wood.

The realistic yellow flame produces carbon monoxide and soot. Under normal conditions, these products are exhausted up the chimney. If fumes or soot, from the gas burning, are evident in the room when the damper is fully open it indicates that the fireplace draft is defective. Do not operate your gas log set until the fireplace draft is corrected.

FOR YOUR SAFETY

Do not store or use gasoline or other flammable vapors and liquids in the vicinity of this or any other appliance.

FOR YOUR SAFETY

WHAT TO DO IF YOU SMELL GAS

1. Do not try to light any appliance.
2. Do not touch any electrical switch; do not use the phone in your building.
3. Immediately call your gas supplier from a neighbor's phone. Follow the gas supplier's instructions.
4. If you cannot reach your gas supplier, call the fire department.

WARNING: If the information in this manual is not followed exactly, a fire or explosion may result causing property damage, personal injury or loss of life.

It is the homeowner's responsibility to assure their fireplace has adequate draft

RECOMMENDED BURN-IN PERIOD

Hargrove gas logs are made of special refractory materials, which withstand high temperatures. One characteristic of this material is retention of moisture. For this reason, we recommend burning the logs for only fifteen minutes during the first burning. After allowing the logs to cool for at least one hour, the set can be burned for any length of time.

WARRANTY

Hargrove gas logs carry a limited lifetime warranty against breakage in the original fireplace. Warranty does not include labor. Burners and grates are warranted for five years. Valves and pilot systems carry a two-year limited warranty in the original fireplace. Outdoor installations carry a one-year limited warranty. See limited warranty information (pg. 13) for complete details.

IMPORTANT INFORMATION

WARNING: This appliance assembly contains burner orifices specifically for the input gas and Btu rating. Modifying or failure to use the factory orifice may cause property damage, personal injury or loss of life.

1. Do not use a natural gas set with propane or a propane set with natural gas.
2. There are many different local codes for gas fire logs. The installation and the provision for combustion and ventilation air must conform to local codes and, or in the absence of local codes, with the National Fuel Gas Code ANSI Z223.1 or the CAN/CSA-B149.1 Installation Code.
3. Gas log sets must be installed by personnel qualified for installing gas appliances.
4. This appliance must be installed only in a solid-fuel burning fireplace with a working flue and constructed of non-combustible materials. Solid fuels are not to be burned in a fireplace where a decorative appliance has been installed.
5. A permanent free opening must be provided by either the fireplace chimney or chimney damper to vent flue gases. Any chimney damper must be fixed in a manner, which will maintain the permanent free opening at all times. Use Tables II and III to determine the minimum permanent free opening based on chimney height and the appliance Btu input rating. Refer to the Damper Stop section for additional directions.
6. The minimum free opening is based only on two factors; chimney height and Btu input rating. Many other factors affect the fireplace drafting. It is the homeowner's responsibility to assure their fireplace has adequate draft. If fumes or soot from the gas burning are evident in the room when the damper is fully open, it indicates that the fireplace draft is defective. Do not operate your gas log set until the fireplace draft is corrected. Consult your fireplace specialist.
7. A fireplace screen must be in place when the appliance is operating and, unless other provisions for combustion air are provided, the screen shall have an opening(s) for introduction of combustion air.
8. When glass fireplace doors are used, always operate gas log set with the glass doors fully open to allow for proper combustion air and to keep control valves from overheating.
9. The minimum inlet supply pressure for the purpose of input adjustment is 3.5 inches (natural gas) 8 inches (propane gas) in water column. The maximum inlet supply pressure is 10.5 inches (natural gas) 13 inches (propane gas) in water column.
10. The appliance and its individual shut-off valve must be disconnected from the gas supply piping system during any pressure testing of that system at test pressures in excess of 1/2 psig (3.5kPa). The appliance must be isolated from the gas supply piping system by closing its individual manual valve during pressure testing equal to or less than 1/2 psig (3.5kPa).
11. The fireplace chimney or venting system should be examined annually and cleaned as required by a qualified agency.
12. The appliance area is to be clear and free from combustible materials, gasoline and other flammable vapors and liquids.
13. After burning for several hours the logs become fragile and should not be handled. Knocking or rubbing logs can cause concrete to crumble and is not covered under the warranty.
14. To clean the logs, use a soft dry paintbrush for periodic dusting of the gas fire logs.
15. To clean the burner, shut off the gas supply, remove the burner pan media, and vacuum the burner ports. After cleaning, replace burner pan media and light the pilot according to the lighting instructions.

FIREPLACE SIZES

Each gas log set requires a minimum 18-inch front opening height and minimum 14.75-inch depth. To determine the largest set that will fit in a fireplace, the width at the center of the fireplace is the critical dimension. Table I below indicates the minimum center width for each size set.

TABLE I				
Set Size	Minimum Center Width	Minimum Front Opening Width	Minimum Depth	Minimum Height
15	17"	19"	14.75"	18"
18	20"	22"	14.75"	18"
24	25"	27"	14.75"	18"
30	31"	33"	14.75"	18"
36	38"	40"	14.75"	18"

TABLE II FACTORY BUILT FIREPLACES

Free Opening Area of Chimney Damper for Venting Combustion Products from Decorative Appliances for Installation in Solid Fuel Burning Fireplaces

MINIMUM PERMANENT FREE OPENING, SQUARE INCHES (FLUE DIAMETER, INCHES)						
CHIMNEY HEIGHT (FEET)	18" SET NG	18" SET LP	24" SET NG	24" SET LP	30" SET NG	30" SET LP
10	28.3 (6")	22.1 (6")	35.3 (7")	28.3 (7")	44.2 (8")	44.2 (8")
15	21.2 (6")	17.3 (5")	26.4 (6")	21.2 (6")	32.2 (7")	32.2 (7")
20	18.1 (5")	14.5 (5")	22.1 (6")	18.1 (5")	26.4 (6")	26.4 (6")
25	15.9 (5")	12.6 (5")	18.1 (5")	15.9 (5")	22.9 (6")	22.9 (6")
30	14.5 (5")	11.3 (4")	17.3 (5")	14.5 (5")	20.4 (6")	20.4 (6")
35	13.2 (5")	10.8 (4")	15.9 (5")	13.2 (5")	18.9 (5")	18.9 (5")
40	12.6 (5")	10.2 (4")	15.2 (5")	12.6 (5")	18.1 (5")	18.1 (5")

TABLE III MASONRY BUILT FIREPLACES

Free Opening Area of Chimney Damper for Venting Combustion Products from Decorative Appliances for Installation in Solid Fuel Burning Fireplaces

MINIMUM PERMANENT FREE OPENING, SQUARE INCHES						
CHIMNEY HEIGHT (FEET)	18" SET NG	18" SET LP	24" SET NG	24" SET LP	30" SET NG	30" SET LP
6	41.7	33.8	49.2	41.7	56.6	56.6
8	38.7	31.2	45.5	38.7	52.4	52.4
10	35.2	28.7	41.7	35.2	48.2	48.2
15	32.0	26.1	37.7	32.0	43.2	43.2
20	28.8	23.7	34.3	28.8	39.8	39.8
30	26.5	21.6	31.2	26.5	35.9	35.9

INSTALLATION

NOTE: Hargrove log sets are to be installed by qualified personnel only. Failure to follow these instructions may cause a fire or explosion resulting in property damage, personal injury or loss of life.

Installer: Please leave these instructions with the homeowner.

Owner: Please retain these instructions for future reference.



Ember Burner



H Burner

BURNER INSTALLATION

IMPORTANT: Before installing in a solid-fuel burning fireplace, the chimney flue and firebox must be free of soot, creosote, ashes and loose paint. Removal of these items should be performed a qualified chimney cleaning company.

1. Turn the gas supply **OFF**.
2. Turn **OFF** all electrical power to blower (if applicable) before installing, servicing or removing appliance.
3. The gas supply line should be ½" Inside Diameter (ID) up to 30 feet and ¾" for longer distances.
4. Hargrove gas log sets are packaged in two boxes (burner/grate assembly in one box and the loose logs in another).
5. Remove the burner from its box. The grate and burner media can be placed aside for later installation.
6. Center the burner from side to side and front to back in the firebox. Ideally, the burner will be aligned directly under the flue damper.
7. Use the 3/8" aluminum connector to connect gas supply line to the gas inlet on the valve (refer to respective valve for inlet location). When bending aluminum tubing use proper bending procedures to avoid kinking the tube.



CPE, LCK, SCK inlet

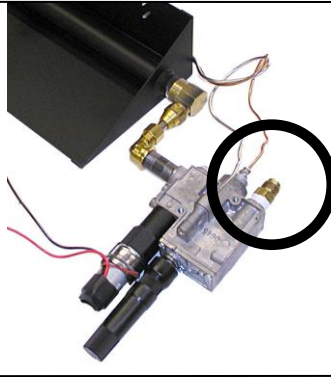

SKC inlet

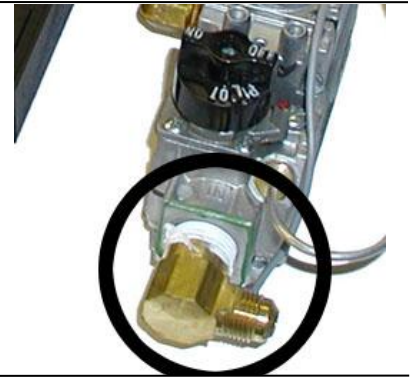

RME inlet

8. Verify that connections are tight, then turn on the gas and check each connection using a soap and water solution. **DO NOT USE AN OPEN FLAME FOR LEAK TESTING.** Any leaks must be corrected prior to proceeding with installation.
9. Determine the valve system that is installed on the appliance, then proceed with lighting the pilot (**Note:** Manual On/Off valve pg. 7 does not have a pilot). Refer to "LIGHTING INSTRUCTIONS" section pages 7-9. Check the pilot flame and main burner operation prior to proceeding with the burner media and log installation (see Fig. 3 and Fig 4).
10. Pilot flame height is preset at the factory and will not normally require adjustment. If field adjustment is required, locate the pilot adjustment screw and turn clockwise for decreased pilot flame or counter-clockwise for increased pilot flame (see LIGHTING INSTRUCTIONS section for pilot adjustment screw location). The upper 1/3 of the thermocouple/thermopile should be engulfed in the pilot flame.

Thermocouple

**Fig. 3
CPE, LCK, SCK & SKC
Pilot**

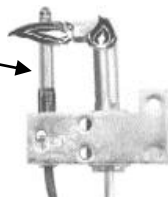

Thermopile

**Fig. 4
RME Pilot**

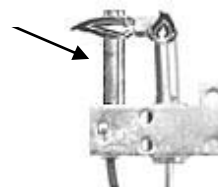

MILLIVOLT VALVE WIRING SCHEMATIC

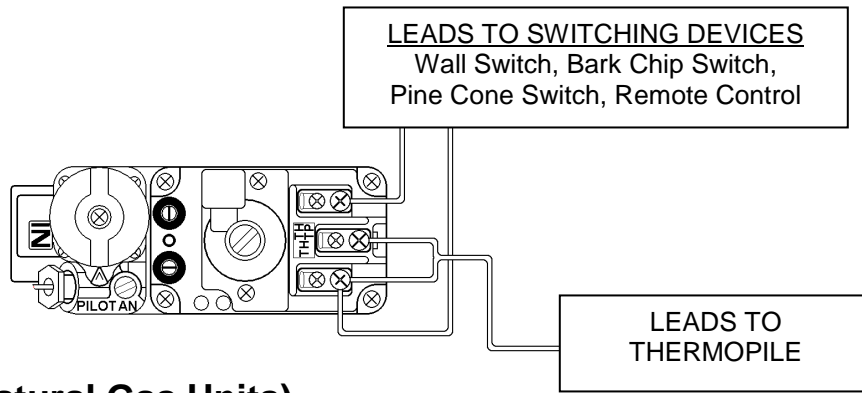

BURNER MEDIA (Natural Gas Units)

1. Locate sand and rock wool. Open the bag of sand, then evenly fill the entire burner pan area.
2. Open the bag of rock wool, then spread it evenly over the sand until it is completely covered. **NOTE:** Tearing the rock wool into smaller pieces and keeping it loosely packed will provide a better ember bed appearance.



BURNER MEDIA (Propane Units)

1. Locate rock wool and vermiculite (VM). (**NOTE:** Sand is used on natural gas units only. If Sand is present in the burner assembly box, the appliance will need to be converted for LP use. **DO NOT USE SAND ON A PROPANE INSTALLATION**). Open bag of VM and fill the burner pan even with the sides. Use the whole bag.
2. Open the bag of rock wool, then spread it evenly throughout the entire burner pan area. **NOTE:** Tearing the rock wool into smaller pieces and keeping it loosely packed will provide a better ember bed appearance.

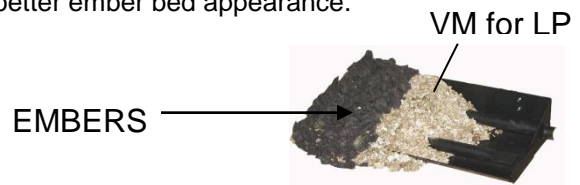

GRATE POSITIONING

The front legs of the grate will rest in front of the burner pipe, on the outside of the burner pan. The grate can be adjusted forward or backward for desired flame presentation.

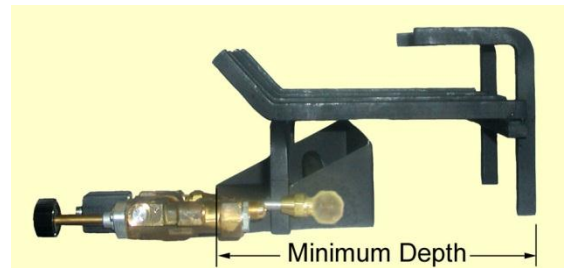

DAMPER STOP INSTALLATION

Attach the damper stop clamp to the fireplace damper blade. Position the clamp to prevent full closure of the fireplace damper blade (see Fig. 3).

If the damper stop provided does not fit, the installer shall install a permanent damper stop that will keep the damper open to a minimum of opening as determined in Table II or III.

CAUTION
THE DAMPER MUST BE FULLY OPEN
WHEN OPERATING THE GAS LOGS!

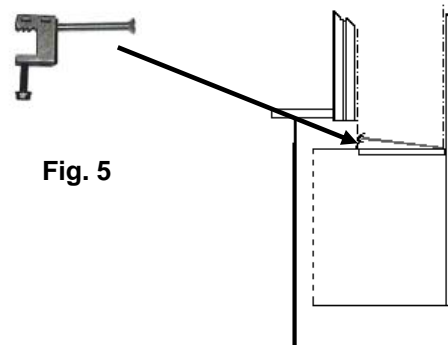

IMPORTANT SAFEGUARDS

1. To avoid personal injury, do not touch hot surfaces when the appliance is operating. Surfaces include: grate, burner, logs and opening of the fireplace.
2. Do not burn real wood or other materials including paper or food products with the log set.
3. Closely supervise children when the appliance is being operated.

CLEANING and INSPECTION

1. Annual inspection and cleaning should be performed by dealer or qualified personnel.
2. Allow logs to cool completely before cleaning.
3. Logs may be cleaned by lightly brushing with a soft bristle brush.
4. Verify flame pattern and log placement for proper operation after cleaning.

Installing the Certification Label

1. Locate the metal Certification Label in the parts pack. (This label shows the model # and serial # along with other pertinent information)
2. Peel the backing off of the label and apply it to the back wall of the Burner Pan as shown in Figure 1.

Applying the Label

Fig. 1

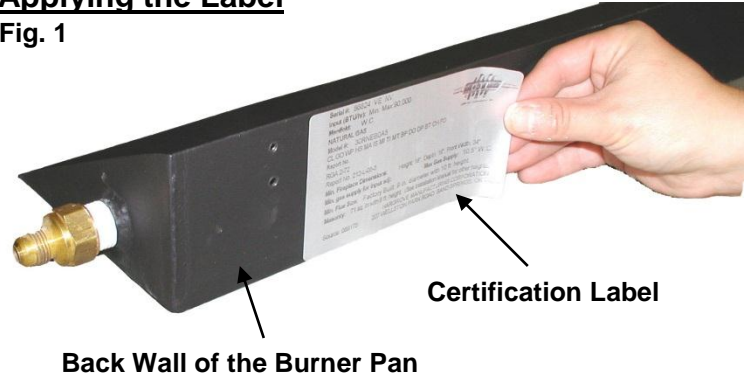

**This space
intentionally
left blank**

COMMON PARTS LIST for 18" to 42" Sets

Natural Gas and Liquid Propane Parts

<u>Description</u>	<u>18" Sets</u>	<u>21"-24" Sets</u>	<u>30" Sets</u>	<u>36" Sets</u>	<u>42" Sets</u>
1. Pedestal Grate	PG-16	PG-20	PG-25	PG-30	PG-36
2. Ember Burner (on EB sets)	EB-14	EB-18	EB-22	EB-26	EB-31
3. H-Burner (on HB sets)	HB-14	HB-18	HB-22	HB-26	N/A
4. Silica Sand (NG)	(1) SD-10	(1) SD-10	(1) SD-10	(2) SD-10	(2) SD-10
5. Rockwool	RW	RW	RW	(2) RW	(2) RW
6. Aluminum Connector (on EB sets)	AC-18	AC-18	AC-18	AC-18	AC-18
7. Damper Stop (optional)	DS	DS	DS	DS	DS
8. Volcanic Cinders	VC	VC	VC	(2) VC	(2) VC
9. Brass End Cap	PPH-6	PPH-6	PPH-6	PPH-6	PPH-6
10. Brass Elbow	49-6-6Z2	49-6-6Z2	49-6-6Z2	49-6-6Z2	49-6-6Z2
11. Brass Orifice	PPH-2	PPH-2	PPH-2	PPH-2	PPH-2
12. Standard Orifice	46-6-8	46-6-8	46-6-8	46-6-8	46-6-8
13. Vermiculite (LP)	VM	VM	VM	(2) VM	(2) VM
14. Air Mixer (LP)	AM 3/8 x 3/8	AM 3/8 x 3/8	AM 3/8 x 3/8	AM 3/8 x 3/8	AM 3/8 x 3/8
15. Air Mixer Nut (LP)	AM-N 3/8	AM-N 3/8	AM-N 3/8	AM-N 3/8	AM-N 3/8
16. No Whistle Flex Connector (on HB sets)	FCNW-18	FCNW-18	FCNW-18	FCNW-18	FCNW-18

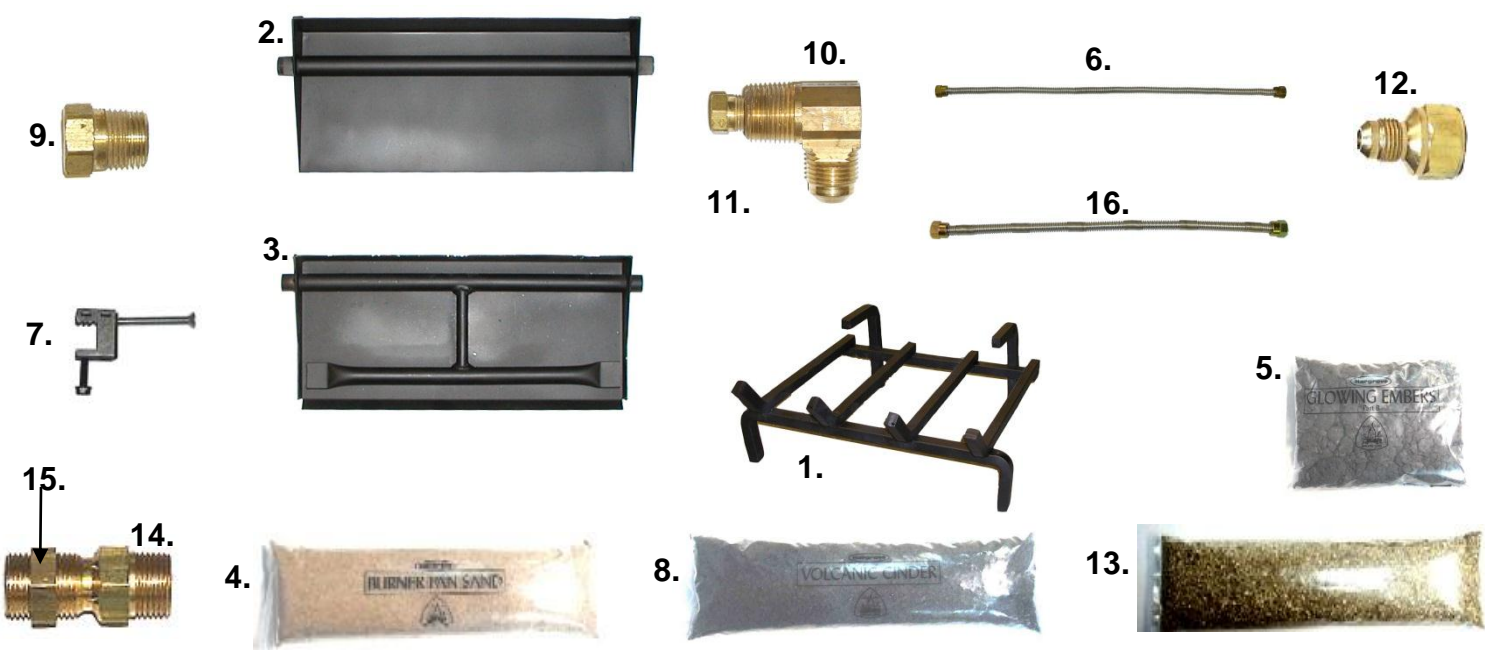

No Valve (See Common Parts List for parts identification)

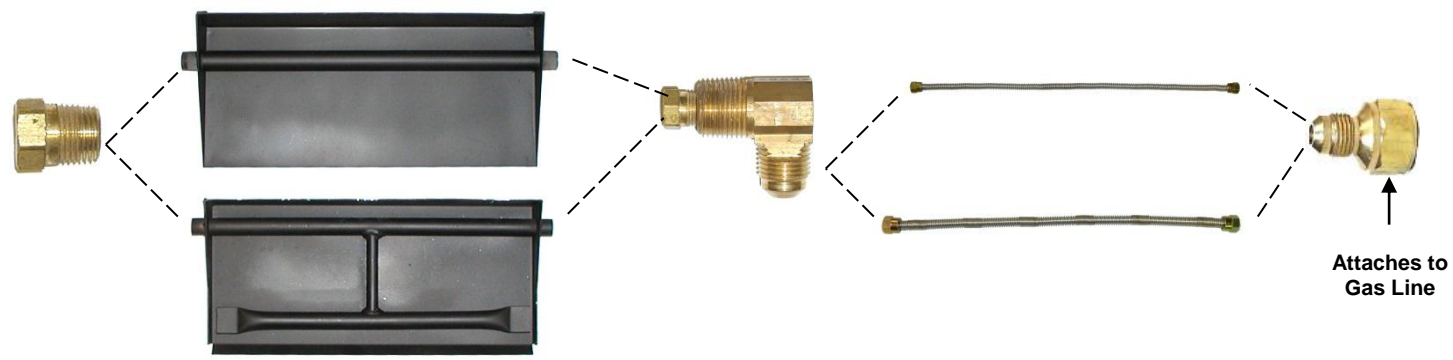

All parts pictured above are included in all accessory kits.

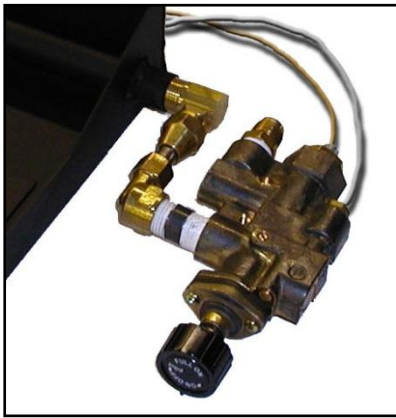

CPC Valve PARTS LIST

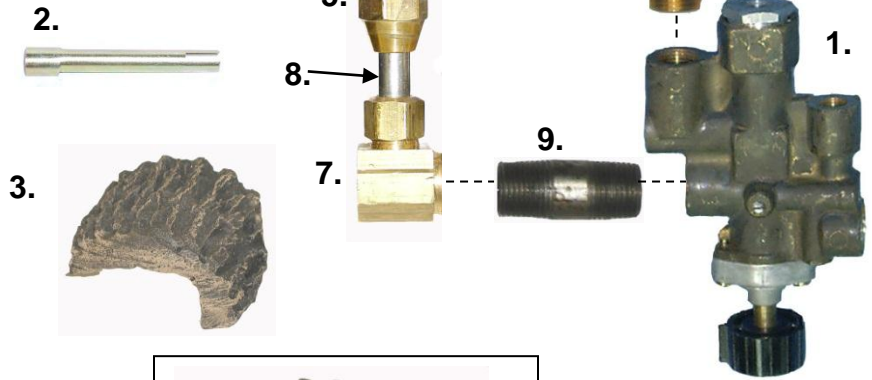

Part #	Description
1. CPC-C	Concentric Safety Gas Valve
2. SPC-EH	Knob Extension Stem (Not Pictured)
3. HSCPCCL	Safety Gas Valve Heat Shield
4. RSTPB-18	Thermocouple & Pilot Burner Assembly
5. 41S-6	Brass Flare Nut
6. 48-6	Brass 3/8" MIP X 3/8" FL
7. 70-6	Brass Elbow 3/8" FIP X 3/8" FL compression
8. SC-1	Stainless Tubing
9. N-6X1.5	3/8" Nipple
10. (2) #8 x 1/2" Screw	Mount Pilot Assembly (Not Shown)



Heat Shield Installation



Latch Tap (LCK) and Servo Tap (SCK) Upgrades (Only for CPC Valve)

Part #	Description
1. CLC-BLOCK or	Latchtap Block
2. CSC-BLOCK	Servo Block
3. 41S-6	Brass Flare Nut
4. SC-1	Stainless Tubing
5. 68-6	Brass 3/8" FIP X 3/8" Compression
6. N-6X1.5	3/8 X 1.5 Pipe
7. LTHS	Latch-Tap Heat Shield

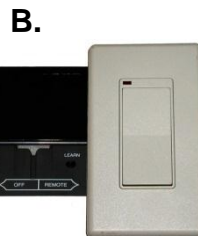
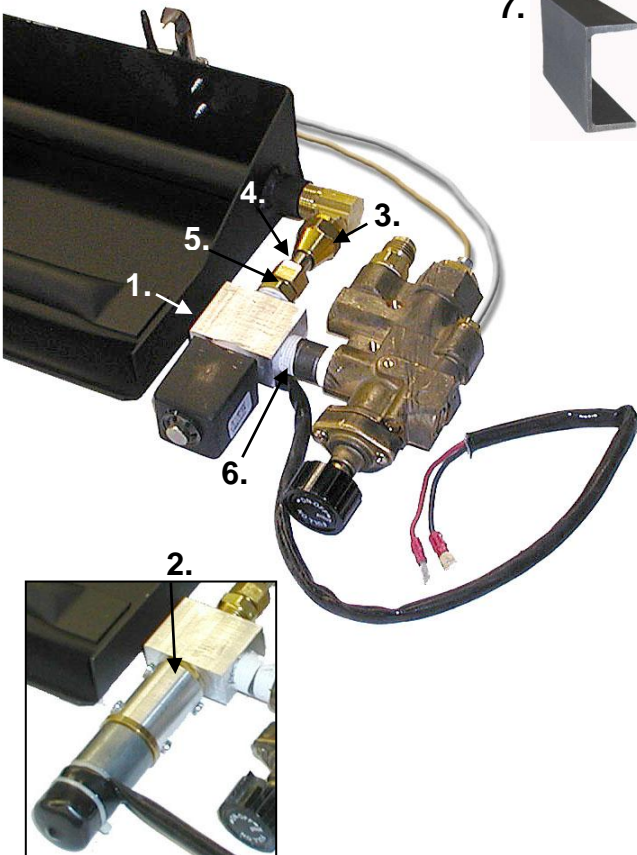

SWITCHING DEVICE FOR MATCHING KIT Servo Tap (REMOTE CONTROL KIT)

- | | |
|---------------------|----------------|
| A. RC-S6V-ST | Remote Control |
| 1. (4) AA Batteries | Not Pictured |
| 2. A23 Battery | Not Pictured |

Servo Tap (WIRELESS WALL SWITCH KIT)

- | | |
|-----------------------|----------------------|
| B. WS-S6V-LTST | Wireless Wall Switch |
| 1. (4) AA Batteries | Not Pictured |
| 2. CR2032 | Not Pictured |

Latch Tap (WALL SWITCH KIT)

- | | |
|---------------------|--------------|
| C. WG-WS | WALL SWITCH |
| 1. (4) AA Batteries | Not Pictured |

Latch Tap (BARK CHIP KIT)

- | | |
|-----------------|------------------|
| D. BPBCS | Bark Chip Switch |
| 1. 9v BATTERY | Not Pictured |

Latch Tap (REMOTE CONTROL KIT)

- | | |
|---------------------|----------------|
| E. RC-S6V-LT | Remote Control |
| 1. (4) AA Batteries | Not Pictured |
| 2. A23 Battery | Not Pictured |

Latch Tap and Servo Tap (WIRELESS WALL SWITCH KIT)

- | | |
|-----------------------|----------------------|
| B. WS-S6V-LTST | Wireless Wall Switch |
| 1. (4) AA Batteries | Not Pictured |
| 2. CR2032 | Not Pictured |

RME Valve PARTS LIST

Part #	Description
1. RSMVNG-C	Robertshaw Millivolt Safety Gas Valve
2. RS-HS-225	Millivolt Valve Heat Shield w/Fiberglass Mat
3. RSTPG-18	Thermopile & Pilot Burner Assembly Kit
4. (2) #8 X 1/2" Screw	Pilot Screws
5. (1) 49-6-8	1/2" X 3/8" 90 degree elbow
6. 69-6-8	1/2 x 3/8FL Tank Fitting
7. WS	Wall Switch
8. Wall Switch Wire	20' of 18-Gauge Wire



2.



6.

8.

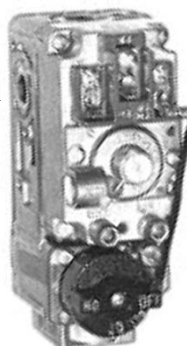

5.



7.

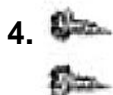

4.

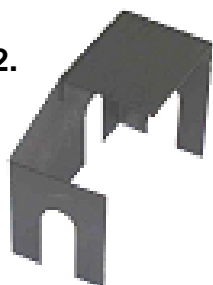

SKC Valve PARTS LIST

Part #	Description
1. SKC-C	Manual Safety Gas Valve
2. SKC-K	Control Knob Stem Extension
3. HSCPCCL	Gas Valve Heat Shield
4. RSTPB-18	Pilot Burner Assembly
5. 48-6	Brass Union 3/8" MIP x 3/8" FL
6. N-6X1.5	3/8" x 3/8" Pipe Nipple
7. 41S-6	Brass 3/8" MIP x 3/8" FL
8. SC-1	1" Stainless Tubing
9. 70-6	Elbow 3/8" FIP x 3/8" FL Comp.
10. RC-S6V-ST	Skytech Remote and Receiver
11. (2) #8X1/2" SCREWS	Pilot Screws
12. LTHS	Servo Heatshield



Heat Shield Installation

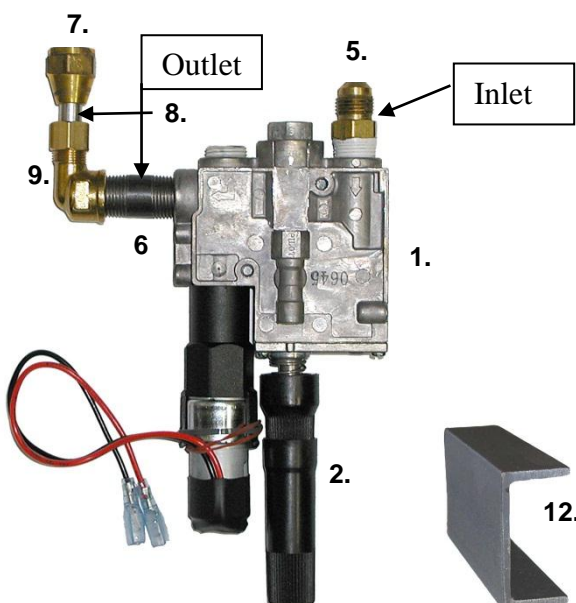
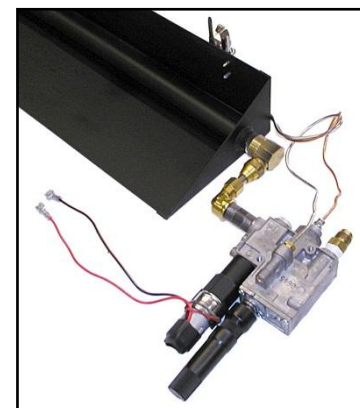

10.



4.

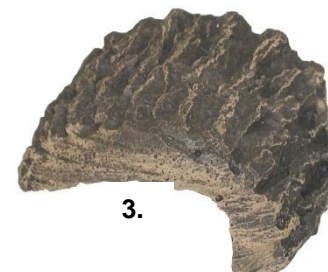

3.

CPC Cool Mount PARTS LIST

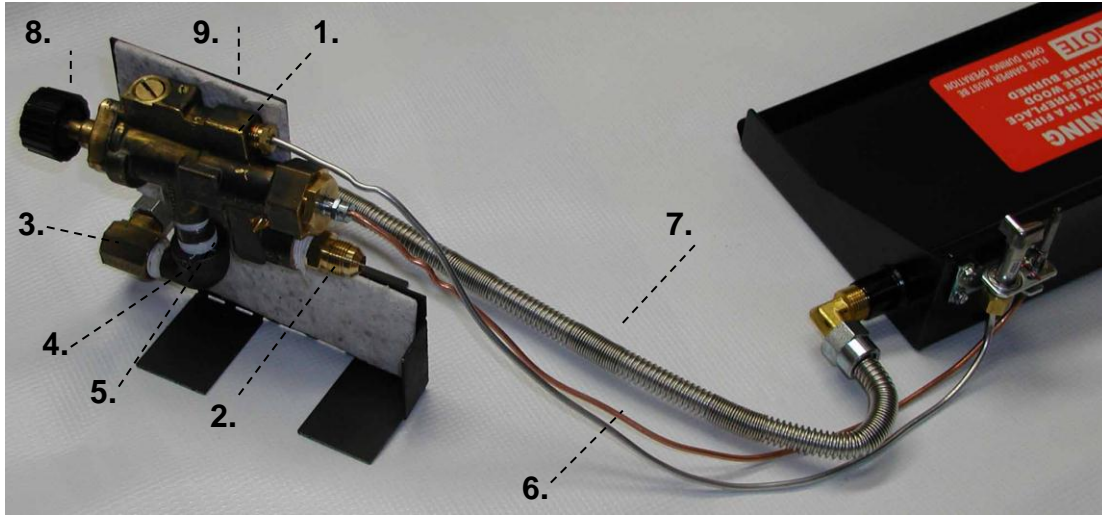

<u>Part #</u>	<u>Description</u>	<u>Part #</u>	<u>Description</u>
11. CPC-C	Safety Pilot Gas Valve	16. RSTPB-18	Thermocouple & Pilot Burner Assembly
12. 48-6	Inlet for gas supply	17. FCNW-18	18" non-whistling flex connector
13. 40-6	Outlet to burner	18. SPC-K	Safety pilot control knob
14. SE-6	3/8" street elbow	19. CPC-VB-REMOTE	Cool mount bracket with superwool
15. N-6x1.5	3/8" nipple 1.5" long		

Latch Tap and Servo Tap Cool Mount PARTS LIST

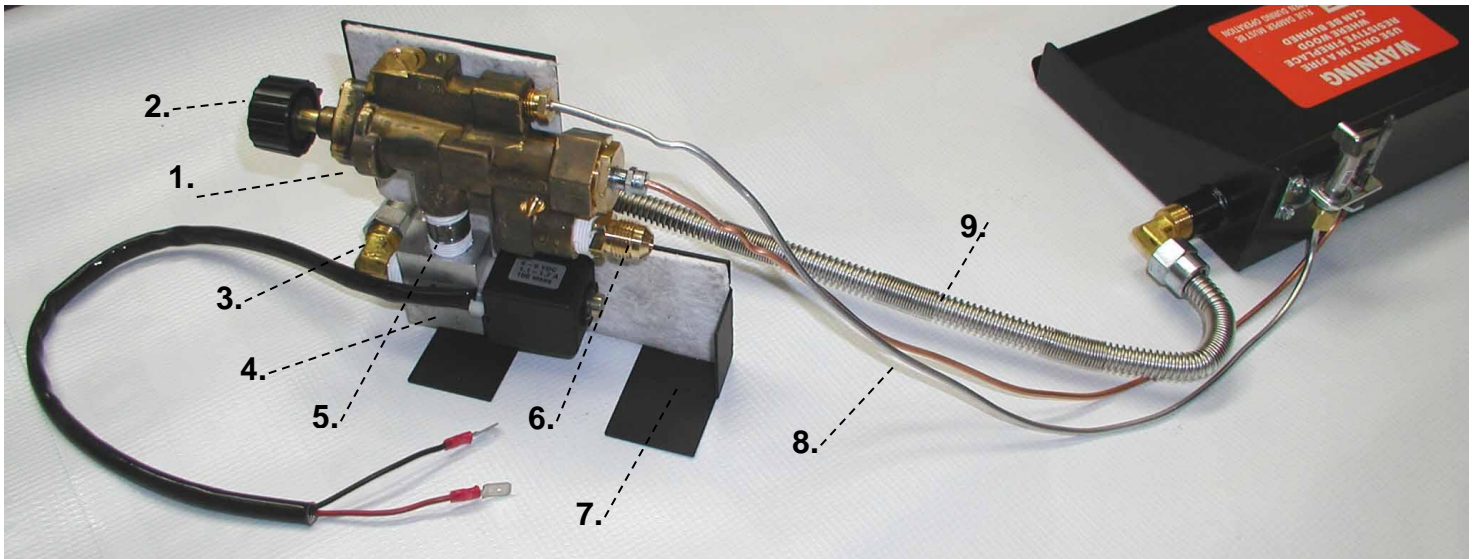

<u>Part #</u>	<u>Description</u>	<u>Part #</u>	<u>Description</u>
1. CPC-C	Safety Pilot Gas Valve	5. N-6x1.5	3/8" nipple 1.5" long
2. SPC-K	Safety Pilot Control Knob	6. 48-6	3/8" brass gas supply inlet
3. 49-6-6	3/8" mpt x 3/8" flare	7. CPC-VB-Remote	Cool mount bracket with superwool
4. CLC-Block	Latch tap block(optional)	8. RSTPB-18	Thermocouple & Pilot Burner Assembly
	Servo tap block(optional) not shown	9. FCNW-18	18" non-whistling flex connector

FOR YOUR SAFETY READ BEFORE LIGHTING

WARNING: If you do not follow these instructions exactly, a fire or explosion may result causing property damage, personal injury or loss of life.

- A. This appliance has a pilot, which must be lit by hand. When lighting the pilot, follow these instructions exactly.
- B. **BEFORE LIGHTING** smell all around the appliance area for gas. Be sure to smell next to the floor because some gas is heavier than air and will settle on the floor.

WHAT TO DO IF YOU SMELL GAS:
 1. Do not try to light any appliance.
 2. Do not touch any electric switch; do not use any phone in your building.
 3. Immediately call your gas supplier from a neighbor's phone. Follow the gas supplier's instructions.
 4. If you cannot reach your gas supplier, call the fire department.
- C. Use only your hand to push in or turn the gas control knob. Never use tools. If the knob will not push in or turn by hand, do not try to repair it. Call a qualified service technician.
- D. Do not use this appliance if any part has been under water. Immediately call a qualified service technician to inspect the appliance and to replace any part of the control system and any gas control, which has been underwater.

LIGHTING INSTRUCTIONS for SAFETY PILOT VALVE

1. STOP! Read the safety information above on this label.
2. Push in gas control knob slightly and turn clockwise to "OFF". 

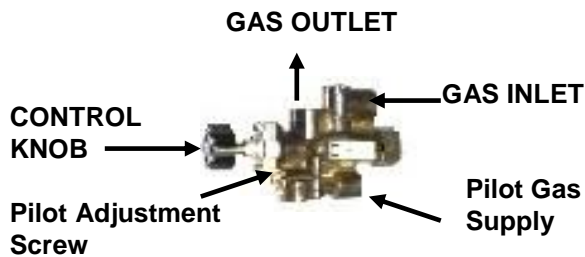

NOTE: Knob cannot be turned from "PILOT" to "OFF" unless knob is pushed in slightly. Do not force.

3. Wait five (5) minutes to clear out any gas. If you then smell gas, STOP! Follow "B" in the safety information above. If you don't smell gas, go to next step.

4. Find pilot – follow metal tube from the gas control behind the burner pan.

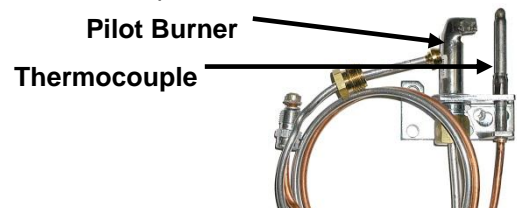

5. Turn knob on gas control counter-clockwise to "PILOT".
6. Push in control knob all the way and hold in. Immediately  light the pilot with a match. Continue to hold the control knob in for about one minute after the pilot is lit. Release knob and it will pop back up. Pilot should remain lit. If it goes out, repeat steps 3 – 7.
 - * If knob does not pop up when released, stop and immediately call your service technician or gas supplier.
 - * If the pilot will not stay lit after several tries, turn the gas control knob to "OFF" and call your service technician or gas supplier.
7. Turn gas control knob counterclockwise to "ON".

TO TURN OFF GAS TO APPLIANCE

1. Turn knob clockwise from "ON" position to the "PILOT" position. Push in the gas control knob slightly and turn clockwise to "OFF".  Do not force knob.

FOR YOUR SAFETY READ BEFORE LIGHTING

WARNING: If you do not follow these instructions exactly, a fire or explosion may result causing property damage, personal injury or loss of life.

- A. This appliance has a pilot, which must be lit by hand. When lighting the pilot, follow these instructions exactly.
- B. **BEFORE LIGHTING** smell all around the appliance area for gas. Be sure to smell next to the floor because some gas is heavier than air and will settle on the floor.
- WHAT TO DO IF YOU SMELL GAS:**
1. Do not try to light any appliance.
 5. Do not touch any electric switch; do not use any phone in your building.
 6. Immediately call your gas supplier from a neighbor's phone. Follow the gas supplier's instructions.
 7. If you cannot reach your gas supplier, call the fire department.
- C. Use only your hand to push in or turn the gas control knob. Never use tools. If the knob will not push in or turn by hand, do not try to repair it. Call a qualified service technician.
- D. Do not use this appliance if any part has been under water. Immediately call a qualified service technician to inspect the appliance and to replace any part of the control system and any gas control, which has been underwater.

LIGHTING INSTRUCTIONS for MILLIVOLT VALVE

1. STOP! Read the safety information above on this label.
2. Push in gas control knob slightly and turn clockwise to "OFF".

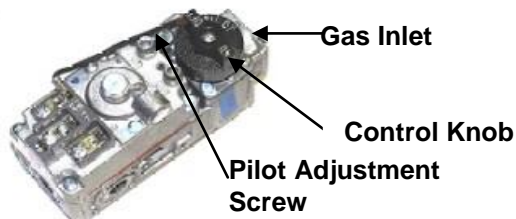

NOTE: Knob cannot be turned from "PILOT" to "OFF" unless knob is pushed in slightly. Do not force.

3. Wait five (5) minutes to clear out any gas. If you then smell gas, STOP! Follow "B" in the safety information above. If you don't smell gas, go to next step.

4. Find pilot – follow metal tube from the gas control behind the burner pan.

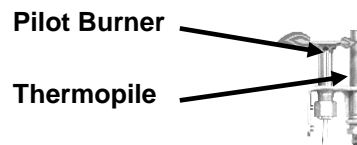

5. Turn knob on gas control counter-clockwise to "PILOT".
 6. Push in control knob all the way and hold in. Immediately light the pilot with a match. Continue to hold the control knob in for about one minute after the pilot is lit. Release knob and it will pop back up. Pilot should remain lit. If it goes out, repeat steps 3 – 7.
- * If knob does not pop up when released, stop and immediately call your service technician or gas supplier.
- * If the pilot will not stay lit after several tries, turn the gas control knob to "OFF" and call your service technician or gas supplier.
7. Turn gas control knob counterclockwise to "ON".

TO TURN OFF GAS TO APPLIANCE

1. Turn knob clockwise from "ON" position to the "PILOT" position. Push in the gas control knob slightly and turn clockwise to "OFF". Do not force knob.

FOR YOUR SAFETY READ BEFORE LIGHTING

WARNING: If you do not follow these instructions exactly, a fire or explosion may result causing property damage, personal injury or loss of life.

- A. This appliance has a pilot, which must be lit by hand. When lighting the pilot, follow these instructions exactly.
- B. **BEFORE LIGHTING** smell all around the appliance area for gas. Be sure to smell next to the floor because some gas is heavier than air and will settle on the floor.
- C. Use only your hand to push in or turn the gas control knob. Never use tools. If the knob will not push in or turn by hand, do not try to repair it. Call a qualified service technician.
- D. Do not use this appliance if any part has been under water. Immediately call a qualified service technician to inspect the appliance and to replace any part of the control system and any gas control, which has been underwater.

WHAT TO DO IF YOU SMELL GAS:

1. Do not try to light any appliance.
2. Do not touch any electric switch; do not use any phone in your building.
3. Immediately call your gas supplier from a neighbor's phone. Follow the gas supplier's instructions.
4. If you cannot reach your gas supplier, call the fire department.

LIGHTING INSTRUCTIONS FOR SKC VALVE

1. STOP! Read the safety information above on this label.
2. Push in control knob slightly and turn clockwise to "OFF".

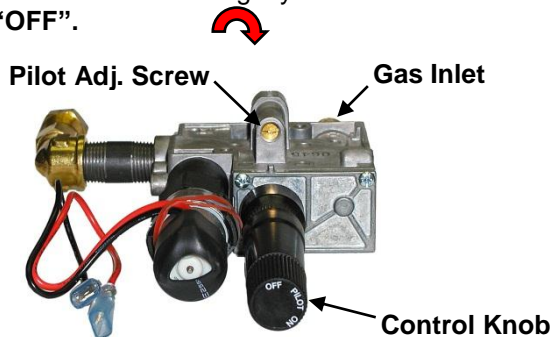

NOTE: Knob cannot be turned from "PILOT" to "OFF" unless knob is pushed in slightly. Do not force.

3. Wait five (5) minutes to clear out any gas. If you then smell gas, STOP! Follow "B" in the safety information above. If you don't smell gas, go to next step.

4. Find pilot – follow metal tube from the gas control behind the burner pan.

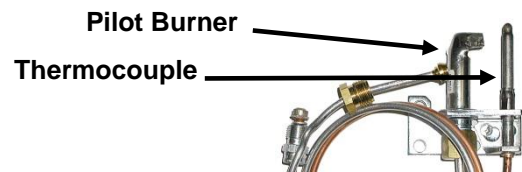

5. Turn knob on gas control counter-clockwise to "PILOT".
6. Push in control knob all the way and hold in. Immediately light the pilot with a match. Continue to hold the control knob in for about one minute after the pilot is lit. Release knob and it will pop back up. Pilot should remain lit. If it goes out, repeat steps 3 – 7.

* If knob does not pop up when released, stop and immediately call your service technician or gas supplier.

* If the pilot will not stay lit after several tries, turn the gas control knob to "OFF" and call your service technician or gas supplier.

7. Turn gas control knob counterclockwise to "ON".
8. Use Remote Control or Wall Switch to adjust main burner flame height

TO TURN OFF GAS TO APPLIANCE



1. Turn knob clockwise from "ON" position to the "PILOT" position. Push in the gas control knob slightly and turn clockwise to "OFF". Do not force knob.

FOR YOUR SAFETY READ BEFORE LIGHTING

WARNING: If you do not follow these instructions exactly, a fire or explosion may result causing property damage, personal injury or loss of life.

- A. **BEFORE LIGHTING** smell all around the appliance area for gas. Be sure to smell next to the floor because some gas is heavier than air and will settle on the floor.
- WHAT TO DO IF YOU SMELL GAS:**
1. Do not try to light any appliance.
 2. Do not touch any electric switch; do not use any phone in your building.
 3. Immediately call your gas supplier from a neighbor's phone. Follow the gas supplier's instructions.
 4. If you cannot reach your gas supplier, call the fire department.
- C. Use only your hand to push in or turn the gas control knob. Never use tools. If the knob will not push in or turn by hand, do not try to repair it. Call a qualified service technician.
- D. Do not use this appliance if any part has been under water. Immediately call a qualified service technician to inspect the appliance and to replace any part of the control system and any gas control, which has been underwater.

LIGHTING INSTRUCTIONS FOR MANUAL VALVE

1. **STOP!** Read the safety information above on this label.
2. **WARNING:** BE SURE THE CHIMNEY DAMPER IS FULLY OPEN.
3. Turn gas control knob clockwise  to fully "OFF" position.
5. Place a lit match on the burner embers. Do not hold match in hand. Turn the gas valve counterclockwise  to the "ON" position.

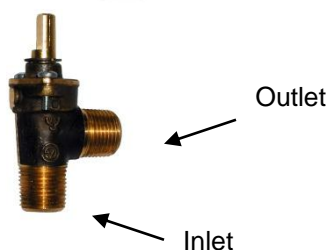

4. Wait five (5) minutes to clear out any gas. If you then smell gas, STOP! Follow "B" in the safety information above on this label. If you don't smell gas, go to next step.

TO TURN OFF GAS TO APPLIANCE

1. Turn knob clockwise from "ON" position to the "PILOT" position. Push in the gas control knob slightly and turn clockwise to "OFF".  Do not force knob.

LIMITED WARRANTY

Refractory Logs

Hargrove gas logs carry a limited lifetime warranty against any manufactured defect or breakage when installed indoors. A replacement will be available from the dealer at which the appliance was purchased. This warranty does not cover breakage caused by excessive handling once installed and fired. Products installed in outdoor applications carry a one (1) year limited warranty.

Burner & Grate

If the burner or grate fails due to deterioration within five (5) years of the verified purchase date, a free replacement will be made available from the dealer at which the appliance was purchased. Products installed in outdoor applications carry a one (1) year limited warranty.

All Other Parts

If any assembled part should fail to operate or be found defective within two (2) years of the verified purchase date, a replacement will be available from the dealer at which the appliance was purchased. Products installed in outdoor applications carry a one (1) year limited warranty.

WHAT IS NOT COVERED

1. Removal and reinstallation costs.
2. Labor costs for replacement or repairs.
3. Transportation or shipping cost.
4. The cost of a service call to diagnose trouble.
5. Painted Surfaces.
6. Damage or defect caused by improper installation, accident misuse, abuse, or alteration.
7. Replacement of rusted burner or combustion chamber resulting from improper storage of the appliance.

LIMITATIONS AND EXCLUSIONS

1. No one has authority to add to or vary this limited warranty, or to create for Hargrove Manufacturing Corporation any other obligation or liability in connection with this appliance.
2. Any implied warranty applicable to this appliance is limited in duration to the same period of time as this written Warranty. Some states do not allow limitations on how long an implied warranty lasts, so the above limitations may not apply to you.
3. HARGROVE MANUFACTURING CORPORATION WILL NOT BE LIABLE FOR INCIDENTAL, CONSEQUENTIAL, SPECIAL OR CONTINGENT DAMAGES YOU MIGHT SUFFER AS A RESULT OF ITS BREACH OF THIS Written WARRANTY OR ANY IMPLIED WARRANTY. Some states do not allow the exclusion or limitation of incidental or consequential damages, so the above limitations or exclusion may not apply to you.
4. This warranty applies only to the original purchase and may not be transferred.
5. If you cannot verify the purchase date of the appliance, the warranty period will begin on the date of which the appliance was manufactured.
6. Replacement or repair parts are warranted for the remaining period of the original part warranty. Warranty parts must be obtained through authorized dealers of this product who will provide original factory replacement parts. Failure to use original factory replacement parts voids this warranty.
7. Purchaser or user agrees to hold Hargrove Mfg Corp. harmless from any and all claims by the buyer as a result of injury or damage to an ultimate user or other person caused by the product sold herein by the seller to the buyer, whether the injury or damage results from the assembly, installation, operation, shipment, storage, or manufacture of this product. Hargrove Mfg Corp. makes no warranties, expressed or implied, other than those expressly stated herein.

YOUR DUTIES

This appliance must be installed by a qualified installer, operated and maintained in accordance with all applicable codes and the instructions furnished with the appliance. You must provide a receipt verifying the purchase date of the appliance when making a warranty claim with the dealer from which the appliance was purchased.

This warranty gives you specific legal rights, and you may also have other rights, which vary from state to state.

CONTACT INFO: Hargrove Manufacturing Corp. Tele: (800) 725-4166