



Burner Systems:

GLASSBRN-18
GLASSBRN-24
GLASSBRN-30
GLASSBRN-36

**INSTALLATION AND OPERATIONS GUIDE FOR
GRAND CANYON GAS LOG SYSTEMS**

Installation and service must be provided by a qualified installer, service agency or gas supplier

Grand Canyon Gas Logs, logs are made of cement refractory material re-enforced with steel fibers. Each of the logs are hand painted and hand finished to recreate the most realistic logs available on the market. The gas burner system is designed to recreate and burn like a real wood burning fireplace with a natural looking flame. With this in mind the gas log sets **MUST** be burned in a fully vented, non-combustible fireplace with the **DAMPER COMPLETELY OPEN** and the chimney free of any obstruction or restrictions. The fireplace must be designed and approved to burn wood.

The realistic flame produced by Grand Canyon Gas Log burners produce carbon monoxide and soot. Under standard conditions these byproducts are exhausted up the chimney. **IF** the fumes or soot from the burning gas are evident in the room when the damper is fully open it indicates that the fireplace draft is defective. **IF** this happens **DO NOT** operate your gas logs until the fireplace draft is corrected, call a service technician to fix the problem.

WARNING: If the information in this manual is not followed exactly, a fire or explosion may result, causing property damage, personal injury or loss of life

- **Do not store or use gasoline or other flammable vapors and liquids in the vicinity of this or any application**

WHAT TO DO IF YOU SMELL GAS

- **Do not try to light any appliance**
- **Do not touch any electrical switch; do not use any phone in the building**
- **Immediately call the gas supplier from a neighbor's phone. Follow the gas supplier's instructions**
- **If you cannot reach the gas supplier, call the fire department.**
- **Installation and service must be performed by a qualified installer, service agency or the gas supplier**

Grand Canyon Gas Log sets are to be installed only in a solid-fuel burning fireplace with working flue and construction of noncombustible material. The installation including provisions for combustion and ventilation air must conform with the *National Fuel Gas Code*, ANSI Z223.1/NFPA 54, or the CSA B149.1 Natural Gas and Propane Installation Code, and applicable local building codes.

A damper clamp is included to maintain the minimum permanent vent opening and to prevent full closure of the damper blade. The chimney damper must be fully opened when burning the log set. The log set is designed to burn with a yellow flame, thus adequate ventilation is absolutely necessary.

To comply with certifications, listings, and building code acceptances, and for safe operation and proper performance of this log set, use only Grand Canyon Gas Logs parts and accessories. Use of other controls, parts, and accessories that are not designed for use with Grand Canyon Gas Logs log set is prohibited and will void all the warranties, certifications, listings and building code approvals, and may cause property damage, personal injury or loss of life.

WARRANTY

Grand Canyon Gas Logs burners and logs carry a lifetime warranty against breakage and defects to the original purchaser. ALL GCGL valves, pilot assemblies and electrical components carry a 2 year warranty as long as installed indoors and installed by a licensed professional. Further warranty information can be found in the warranty section of this guide.

INSTALLER: Leave this manual with the log set
CONSUMER: Retain this manual for future reference.

IMPORTANT INFORMATION

WARNING: This appliance assembly contains burner orifices specifically for the input gas specified on the burner and box, as well as the Btu rating specified in this manual. Modifying or failure to use the factory orifice may cause property damage, personal injury or loss of life.

Read these instructions completely before installing and using Grand Canyon Gas Log system.

1. Gas type will be indicated on the burner and the box. Do not use a natural gas burner with propane or a propane burner with natural gas.
2. The installation, provisions for combustion, and ventilation air must conform to the National Fuel Gas Code, *ANSI Z223.1/NFPA54*, or the *CSA B 149.1*, National Gas and Propane Installation Code.
3. For warranty to be valid gas log sets must be installed by a NFI certified or other qualified professional installer.
4. This appliance must be installed only in a solid-fuel burning fireplace with a working flue and constructed of non-combustible materials. Solid fuels are not to be burned in a fireplace where a decorative appliance has been installed.
5. A permanent free opening must be provided by either the fireplace chimney or chimney damper to vent carbon monoxide and other flue gases. Any chimney damper must be fixed in a manner, which will maintain the permanent free opening at all times. Use the table at the bottom of this page to determine the minimum permanent free opening based on chimney height and the appliance Btu rating.
6. A fireplace screen must be in place when the appliance is operating and, unless other provisions for combustion air are provided, the screen shall have an opening(s) for introduction of combustion air. With use of glass doors, doors must be open while the appliance is burning to assure proper ventilation.
7. The minimum inlet supply pressure for the purpose of input adjustment is 5.0 inches (natural gas) 8.0 inches (propane) in water column. The maximum inlet supply pressure is 10.5 inches (natural gas) 13.0 inches (propane) in water column.
8. The appliance and its individual shut-off valve must be disconnected from the gas supply piping system during any pressure testing of that system at test pressures in excess of ½ psig (3.5kPa). The appliance must be isolated from the gas supply piping system by closing its individual manual valve during pressure testing equal to or less than ½ psig (3.5kPa).
9. The appliance area is to be clear and free from combustible materials, gasoline and other flammable vapors and liquids.
10. Do not use this appliance if any part has been under water. Immediately call a qualified service technician to inspect the appliance and to replace any gas control which has been under water.

FIREPLACE SIZE REQUIREMENTS

Burner Size	Min. Fireplace Dimensions				BTU	
	Width		Depth	Height	NAT.	L.P.
	Front	Rear				
18"	30"	18"	12"	14"	52K	49K
24"	36"	24"	12"	14"	64K	66K
30"	42"	30"	14"	14"	76K	79K
36"	48"	39"	14"	14"	81K	83K

IMPORTANT

For all valves, the air MUST be purged from the gas line before the pilot will light and burn properly. The time needed to purge will depend on the length of the gas line to the unit and the amount of time since the unit or gas line was last used. It may take several minutes before all the air is purged and the pilot will light and burn properly. Follow the LIGHTING INSTRUCTIONS section in this manual.

MINIMUM CHIMNEY HEIGHT AND FLUE OPENING

For Factory Built Fireplaces Free Opening Area Of Chimney Damper For Venting Combustion Products From Decorative Appliances For Installation In Solid Fuel Burning Fireplaces

Chimney Height* (ft)	Appliance Input Rate (kBTU/hr)											Max. Input***
	20	30	40	50	60	70	80	90	100	110	120	
	Minimum Opening** (sq. in.)											
10	11.3	16.6	22.1	28.3	35.3	44.2	—	—	—	—	—	77.6
15	8.6	12.6	17.3	21.2	26.4	32.2	38.5	45.4	—	—	—	98.2
20	7.5	10.8	14.5	18.1	22.1	26.4	31.2	37.4	43.0	—	—	114.2
25	6.6	9.6	12.6	15.9	18.1	22.9	27.3	31.2	36.3	43.0	50.3	121.0
30	6.2	9.1	11.3	14.5	17.3	20.4	24.6	28.3	33.2	37.4	44.2	130.1
35	5.7	8.0	10.8	13.2	15.9	18.9	22.1	25.5	30.2	34.2	39.6	141.2
40	5.3	7.5	10.2	12.6	15.2	18.1	20.4	23.8	27.3	31.2	35.3	158.5

* Height is from hearth to top of chimney and the minimum height is 10 feet. (See Figure 3, Factory Built Fireplace.)

** Chart shows minimum opening (sq. in.) for the given height and input rate.

*** Column marked "Max. Input" corresponds to the maximum allowable input rate (kBTU/hr) for the given height.

For Masonry Built Fireplaces Free Opening Area Of Chimney Damper For Venting Combustion Products From Decorative Appliances For Installation In Solid Fuel Burning Fireplaces

Chimney Height* (ft)	Appliance Input Rate (kBTU/hr)										
	20	30	40	50	60	70	80	90	100	110	120
	Minimum Opening** (sq. in.)										
6	17.6	25.7	33.8	41.7	49.2	56.6	64.0	71.4	78.8	86.2	93.5
8	16.5	23.7	31.2	38.7	45.5	52.4	59.7	66.9	74.1	81.3	88.6
10	15.1	21.7	28.7	35.2	41.7	48.2	54.3	60.2	66.1	72.0	77.9
15	14.1	19.9	26.1	32.0	37.7	43.2	48.8	54.1	59.4	64.6	69.9
20	12.9	18.5	23.7	28.8	34.3	39.8	44.4	49.1	53.8	58.4	63.0
30	12.2	16.9	21.6	26.5	31.2	35.9	40.3	44.5	48.6	52.7	56.6

* Height is from hearth to top of chimney and the minimum height is 6 feet. (See Figure 3, Factory Built Fireplace.)

** Chart shows minimum opening (sq. in.) for a given height and input rate.

BOX CONTENTS

1. Burner
 - a. GLASSBRN-18 (18" x 10")
 - b. GLASSBRN-24 (24" x 10")
 - c. GLASSBRN-30 (30" x 10")
 - d. GLASSBRN-36 (36" x 10")
2. Flex line (not pictured)
3. Damper Clamp (not pictured)
4. Lava Rock (Optional)
 - a. Suggested Amounts
 - i. 18" = 10 lbs.
 - ii. 24" = 20 lbs.
 - iii. 30" = 30 lbs.
 - iv. 36" = 40 lbs.
5. ½" Reflective Glass (Optional)
 - a. Suggested Amounts
 - i. 18" = 10 lbs.
 - ii. 24" = 20 lbs.
 - iii. 30" = 30 lbs.
 - iv. 36" = 40 lbs.



MAINTENANCE

Burning Grand Canyon Gas Logs for any length of time will cause the logs to soot. Soot only accumulates on the log therefore the burner will not need cleaning. Soot is caused by incomplete combustion of the gas leaving behind a dark dense material. Soot will also accumulate on the logs if the logs are not placed in the proper position according to the log placement diagrams. To clean off soot use an old tooth brush and gently rub away the soot. Periodic examination and cleaning of the venting system and the solid fuel-burning fireplace, including frequency of such examination and cleaning, by a qualified agency. Periodic examination of the pilot assembly should be in accordance with the provided picture.



INSTALLATION

The damper clamp with hex bolt is provided as a means to prevent full closure of the damper blade. The clamp is easily attached to most, damper blades with pliers or a wrench, and must be permanently installed. The clamp is designed to prevent accidental closure of the damper when installed. Should the clamp not fit or fail to provide the permanent vent opening listed in the table above, have a permanent stop installed, remove the damper blade or have the damper cut to provide the minimum permanent opening required.

The Grand Canyon Gas Log set must be installed by a qualified professional service technician. Instructions must be followed carefully to ensure proper performance and full benefit from the gas log set. Check to be sure the log set is designed and labeled for the type of gas (natural or propane) supplied to the fireplace. Fireplace floor must be level clear of debris and smooth.

WARNING: Failure to position the parts in accordance with this manual or failure to use only parts specifically approved with this appliance may result in property loss, personal injury, or loss of life.

BURNER INSTALLATION:

1. Make sure the fireplace gas supply is turned off
2. Locate the gas-supply stub inside the fireplace and remove the cap. When removing the cap make sure the stud does not turn, loosening the connection inside the wall.
3. Center the burner from side to side and position it as close to the back wall of the firebox. Ideally, the burner will be aligned directly under the flue damper.
4. Use the 3/8" aluminum flex line connector to connect the gas supply line to the gas inlet on the valve. When bending the aluminum flex line use proper bending procedures to avoid kinking the tubing.
5. Verify that connections are tight, then turn on the gas and check each connection using soap and water solution. **DO NOT USE AN OPEN FLAME FOR LEAK TESTING.** The soap and water connection should be 50% water and 50% soap. Brush the solution over the connections and check for bubbles. Any leak must be corrected prior to proceeding with installation.
6. Determine the valve system that is installed on the appliance, then proceed with lighting the pilot (**NOTE:** Manual on/off valves do not have a pilot).
7. Before lighting the appliance make sure the heat shield is placed back in the position it was when the appliance was taken out of the box.

BURNER MEDIA INSTALLATION:

1. Locate vermiculite (3 burner and LP units only) and the rock wool (Glowing Embers). Vermiculite is used for all propane units and for the ember burner on the 3 burner appliance.
 - a. Open the vermiculite, then evenly fill the entire ember pan area,
2. Open the bag of rock wool, then spread it evenly throughout the entire ember pan area. Tear the rock wool into smaller pieces and keeping it loosely packed will provide a better ember bed appearance.

Models: AF-LMF, AF-LMF/R, AF-LMF/RD, AF-LMF-RVS INSTALLATION AND OPERATION INSTRUCTIONS

IF YOU CANNOT READ OR UNDERSTAND THESE INSTALLATION INSTRUCTIONS DO NOT ATTEMPT TO INSTALL OR OPERATE

INTRODUCTION

These instructions apply to LMF Series valve kits: These Natural gas safety pilot kits are designed to be used with 18 to 30-inch gas logs sets purchased separately as a complete valve kit. These control systems were developed to provide safe, reliable, user-friendly remote control system for gas heating appliances.

Optional LP conversion kits AFLPK-18, AFLPK-24 and #685-25 Pilot Orifice Kits are available.

Important: Read these instructions carefully before starting installation of your log set.

What to do if you smell gas?

- Do not try to light the appliance
- Do not touch any electrical switch
- Do not use any phone in your building
- Immediately call your gas supplier from a neighbor's phone. Follow the gas suppliers instructions.
- If you cannot reach your gas supplier, call the fire department.

Warning: Improper installation, adjustment, alteration, service or maintenance can cause injury or property damage. Refer to this manual. For assistance or additional information consult a qualified installer, service agency or gas supplier.

For Your Safety: Do not store or use gasoline or other flammable vapors and liquids in the vicinity of this or any other appliance.

Notice: Please leave these instructions for the consumer. Retain for future reference.

Young children should be carefully supervised when they are in the same room as the appliance.

Be sure flue damper and glass doors are fully open when operating any vented gas log set.

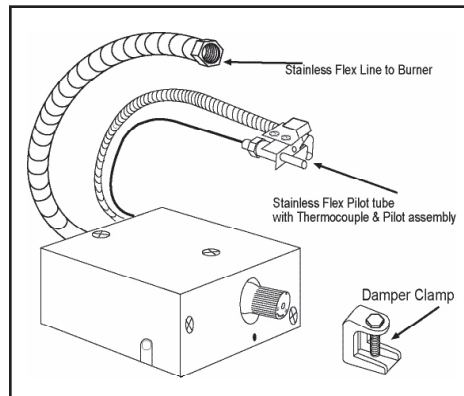

AF-LMF
Manual ON/OFF Gas Valve

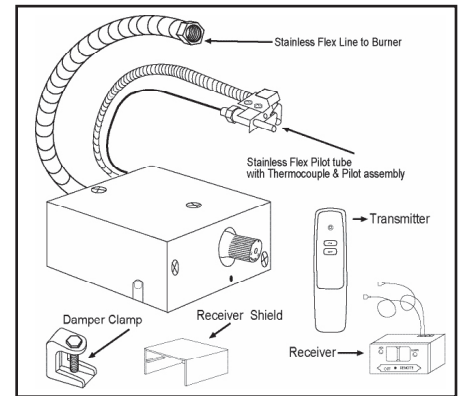

AF-LMF/R
Manual ON/OFF Gas Valve with Solenoid and ON/OFF Remote

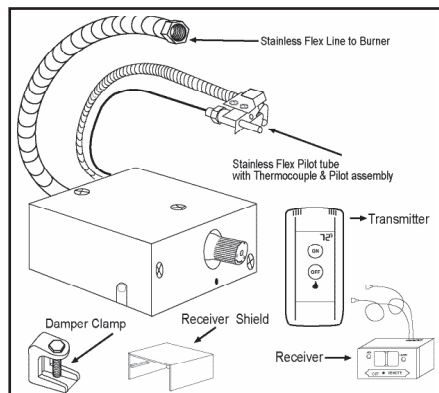

AF-LMF/RD
Manual ON/OFF Gas Valve with Solenoid and ON/OFF (Touch Screen) Remote

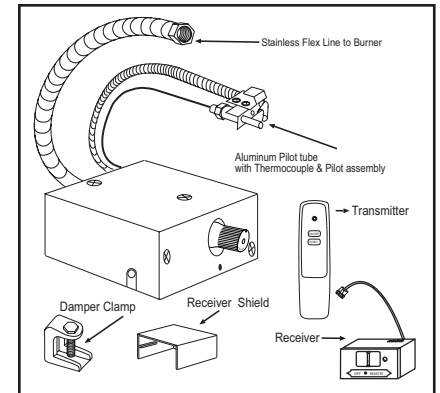

AF-LMF/RVS
Manual ON/OFF Gas Valve with Step Motor and ON/OFF (Hi/Med/Lo) Remote

WARNING

This control system must be installed exactly as outlined in these instructions. Read all instructions completely before attempting installation. Follow instructions carefully during installation. Any modifications of this control or any of its components will void the warranty and may pose a fire hazard.

These instructions must be used as a supplement to the instructions supplied with the gas log set. Follow the gas log instructions supplied by the manufacturers on the placement of the burner pan, log basket grate, burner media (sand or vermiculite), ember material and the log placement. Please follow these instructions on the connection of the inlet line to the gas valve and then to the burner pan assembly.

If your fireplace installation has glass doors, only operate the fireplace with glass doors in the fully open position.

INSTALLATION: VALVE KIT WITH PRE-EXISTING LOG SET

1. Make sure all gas flow is completely turned off to the gas log set. Make sure you have a certified and approved shut-off within 6-feet of the fireplace, or whatever the local inspection authority requires.
2. Remove all logs and basket grate and set aside.
3. Disconnect the 3/8" Flared fitting at the existing manual valve from the inlet gas supply.
4. Remove existing manual valve and fittings on the burner pan.
5. Locate a position on the back of the burner pan about 4-inches from the right or left side of the burner pan. (Figure #1 & #2)
6. Mount pilot assembly to burner pan as shown in Figure # 3. Note this pilot bracket clips on the burner pan and holds the pilot at a 45-degree position onto the pan with no screws required. A screw can be added to secure the pilot assembly if needed. Bend 1/4" stainless pilot tubing from pilot assembly until the bottom of the pilot bracket is resting against the pan. (This will hold the pilot at the 45 degree position) then connect pilot fitting to valve. **(Use caution when bending pilot tubing not to kink the tubing or locate the tubing in or over the burner pan).**
7. Locate the valve kit in the right or left front corner of the firebox as far forward as possible (See Figure #4).
8. Bend inlet gas supply line and connect the 3/8" flare fitting to gas valve 3/8" inlet connector (Fitting with printed label) (Use caution not to kink the line when bending).
9. Bend 12" stainless flex line and connect to valve outlet then connect other end to 3/8" flare fitting on burner pan **(Caution do not let gas inlet line to the valve kit or gas outlet line from the valve kit be placed in or over the burner pan).**
10. Turn on gas supply and check all connections for leaks using soapy water solution.
11. Follow valve pilot lighting instructions. After pilot is lit, check pilot fittings for leaks.
12. Reinstall basket grate and logs.
13. Install Damper stop (supplied with this valve kit) (This allows damper to remain slightly open to allow the pilot to vent)

NOTE: On all PROPANE installations it is recommended that an inlet pressure regulator be used.

INSTALLATION: VALVE KIT WITH NEW LOG SET

1. Make sure all gas flow is completely turned off to the fireplace. Make sure you have a certified and approved shut-off within 6-feet of the fireplace, or what ever the local inspection authority requires.
2. Follow the instructions supplied with the log set to locate the burner pan. Using the fittings, orifice and gas supply line that came with the log set, connect the line to the inlet gas supply.
3. Locate a position on the back of the burner pan about 4-inches from the right or left side of the burner pan. Note: (Figure #1 & #2)
4. Mount pilot assembly to burner pan as shown in (Figure #3). Note this pilot bracket clips on the burner pan and holds the pilot at a 45-degree position onto the pan and no screws required. Note: A screw can be added to secure the pilot assembly if needed. Bend 1/4" stainless pilot tubing from pilot assembly until the bottom of the pilot bracket is resting against the pan. (This will hold the pilot at the 45 degree position) then connect pilot fitting to valve. **(Use caution when bending pilot tubing not to kink the tubing or locate the tubing in or over the burner pan)**
5. Locate the valve kit in the right or left front corner of the firebox as far forward as possible (See Figure #4)
6. Bend inlet gas supply line and connect the 3/8" flare fitting to gas valve 3/8" inlet connector **(Fitting with printed label) (Use caution not to kink the line when bending).**
7. Bend 12" stainless flex line and connect to valve outlet then connect other end to 3/8" flare fitting on burner pan (Caution do not let gas inlet line to the valve kit or gas outlet line from the valve kit be placed in or over the burner pan).
8. Turn on gas supply and check all connections for leaks using soapy water solution.
9. Follow valve pilot lighting instructions. After pilot is lit check pilot fittings for leaks.
10. Follow the instructions supplied with the log set to install ember material, basket grate and logs.
11. Install Damper stop (supplied with this valve kit) (This allows damper to remain slightly open to allow the pilot to vent).

NOTE: On all PROPANE installations it is recommended that an inlet pressure regulator be used.

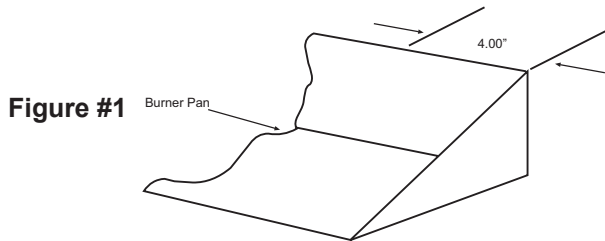

Figure #1

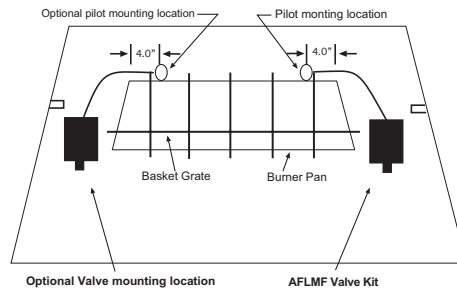

Figure #2

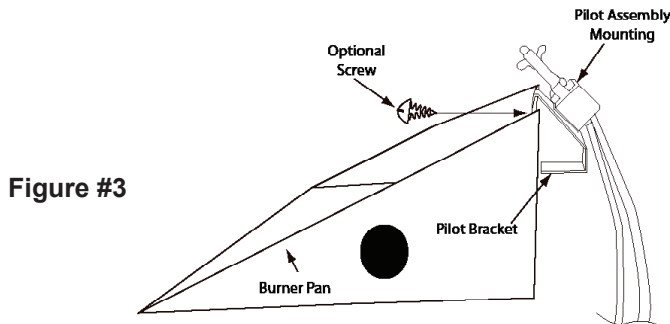

Figure #3

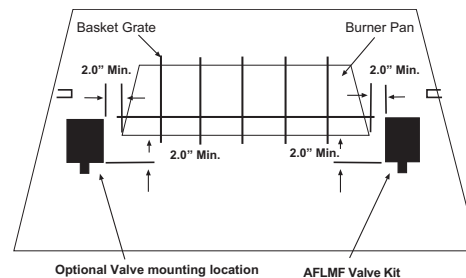

Figure #4

CONNECTING THE REMOTE CONTROL ON AF-LMF/R & AF-LMF/RD & AF-LMF-RVS VALVE KITS

1. The remote control receiver is to be placed next to the valve kit, away from the fire (Note: Figure #5).
2. Remove receiver shield and battery cover then install (4) AA alkaline batteries. Reinstall receiver shield.
3. Connect the red and black wires from the ON/OFF latching solenoid on the valve to the red and black wires from the remote receiver. If installing the AF-LMF-RVS connect the 4-pin connector from the step motor to the remote receiver (Figure #6).
4. Refer to the instructions supplied with the remote control for operation of the remote control.

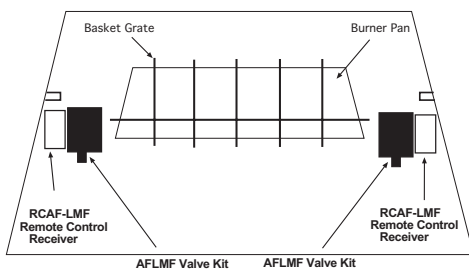

Figure #5

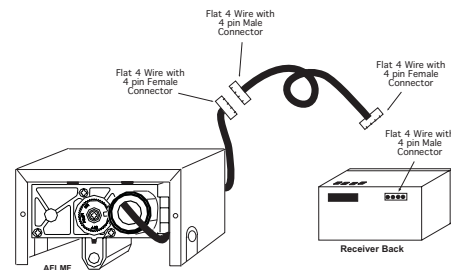

Figure #6

LIGHTING & SHUT OFF PROCEDURES

WARNING: IF YOU DO NOT FOLLOW THESE INSTRUCTIONS EXACTLY, A FIRE OR EXPLOSION MAY RESULT CAUSING PROPERTY DAMAGE, PERSONAL INJURY OR LOSS OF LIFE.

- This product has a standing pilot, which must be lit by hand. When lighting the pilot, follow these instructions exactly.
- This product should be installed including provisions for combustion and ventilation air, must conform with local codes or, in the absence of local codes, to the National Fuel Gas Code, ANSI Z223 latest addition.
- This product must be on a gas supply line that is less than 1/2 psi. and with an individual manual shut off.
- Never operate this new system with the glass fireplace enclosures (doors) in the closed position.
- Connecting 110-volt electrical power to this product will cause damage and will void warranty.

PILOT GAS AND LIGHTING PROCEDURE

1. Turn the gas control knob counterclockwise to the **PILOT** position, push the gas control knob IN and HOLD in position. This will open the pilot valve and allows gas to flow to the pilot burner.
2. Light the pilot burner while holding the gas control knob in until a strong pilot flame is present. (Approximately 60-seconds)
3. Release the gas control knob and verify the pilot flame remains lit.
4. Turn the gas control knob counter clockwise to the **ON** position, The main burner valve will open and the main burner will ignite,

SHUT OFF PROCEDURE

1. To shut **OFF** the main burner while leaving the pilot **ON**, turn the gas control knob clockwise to the **PILOT** position. This action will close the main gas flow.
2. To shut **OFF** the main burner and pilot, turn the gas control knob clockwise to the **OFF** position. This action will close the main gas valve and disengages the safety pilot valve. However the power unit must drop out before the lighting sequence can begin again. This may take as long as 3 minutes.
3. To relight the pilot, follow the steps in the Pilot Gas and Lighting Procedure section.

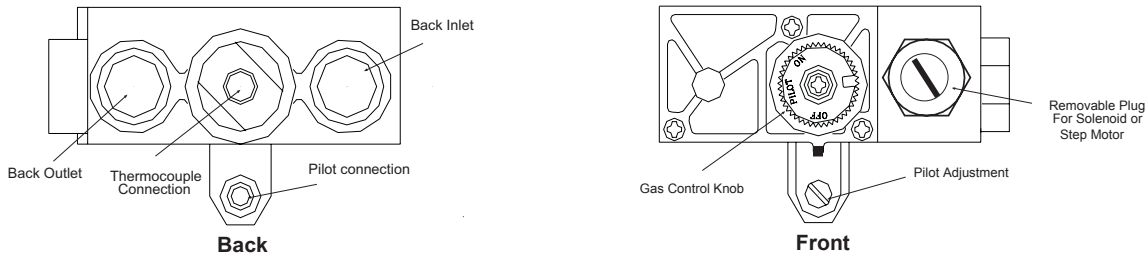

MAINTENANCE OF YOUR AF-LMF, AF-LMF/R, AF-LMF/RD & AF-LMF-RVS

- Your system should be checked once a year (At the start of the heating season) for proper operation by a qualified serviceman.
- Items to check: Valve operation, pilot operation, switch operation, damper operation, visual check of the burner and gas connections for leaks.

PARTS LIST

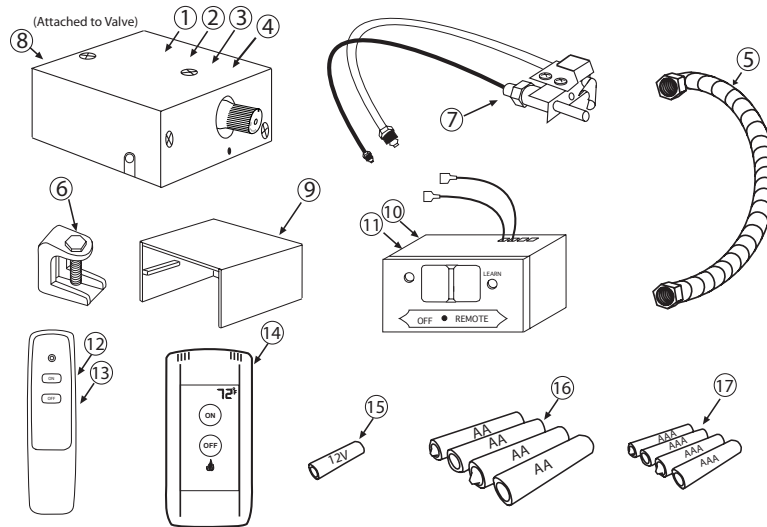

1. AF-LMF Valve Assembly	SS-1-010-1000
2. AF-LMF /R Valve Assembly	SS-2-010-1000
3. AF-LMF /RD Valve Assembly	SS-2-101-1000
4. AF-LMF /RVS Valve Assembly	SS-2-080-1002
5. 10-inch Stainless Flex Connector	SS-3-093-1000
6. Damper Stop	SS-3-170-1001
7. Pilot Assembly	SS-3-091-1000
8. 3/8" Flare x 3/8" NPT Connector	SS-3-093-1000
9. Receiver Shield	SS-3-170-1000
10. 6-volt DC Receiver (For R & RD Models)	SS-3-030-1003
11. 6-volt DC Receiver (For RVS Model)	SS-3-030-1001
12. ON/OFF Transmitter (Con1001) R Model	SS-3-020-1000
13. ON/OFF Transmitter (SKY5001) RD Model	SS-3-020-1001
14. ON/OFF Hi/Med/Lo Transmitter (RCAF-1035) for RVS Model	SS-3-020-1003
15. 12-volt Battery (1 Required for R & RVS Model Transmitters)	SS-1-060-1000
16. AA Battery (4 Required for R & RD receivers)	SS-1-060-1001
17. AAA Battery (4 Required for RD Transmitter)	SS-1-060-1002

LIMITED WARRANTY

American Flame warrants the AF-LMF Valve Kit for 12 months from the date of purchase or installation to the original purchaser to be free from defects in materials and workmanship. Damage to the AF-LMF Valve Kit caused by accident, misuse, abuse, or installation error, whether preformed by a contractor, Service Company, or owner, is not covered by this warranty. American Flame will not be responsible for labor charges and/or damage incurred in installation, repair, replacement, or for incidental or consequential damage. Some states, provinces, and nations do not allow exclusion or limitations of incidental or consequential damages, so the above limitations or exclusions may not apply. This warranty gives you specific legal rights. You may also have other rights that vary by state, province, or nation.

For Technical Service, call:

U.S. INQUIRIES

(888) 672-8929 or (260) 459-1703

Web site: www.skytechsystem.com

CANADIAN INQUIRIES

(877) 472-3923

MANUFACTURED EXCLUSIVELY FOR SKYTECH II, INC