

# 45 AND 60 UNIVERSAL REMOTE INSTALLATION AND OPERATION INSTRUCTIONS

## 1. RECEIVER INSTALLATION

The receiver can be installed as either a wall mount or a appliance mount. Depending on your application, follow the applicable steps below after having completed step 1.1.

Turn off the electrical power and the gas supply to the appliance. Make sure the slide switch on the receiver is set to the "OFF" position.

1.1 Either disconnect the existing switch wiring at the valve, or connect in parallel with any other switch wiring at the valve. For millivolt switch wiring attach the wires to terminal I (marked TPTH) and terminal 3 (marked TH) of the gas valve from the output terminals on the receiver. **FIGURE 1 NOTE:** If connecting the receiver to an appliance with electronic ignition, connect the receiver wires to the two leads from the control module, identified as switch wires. (It may be necessary to remove the spade connectors and join the wires using wire connectors)

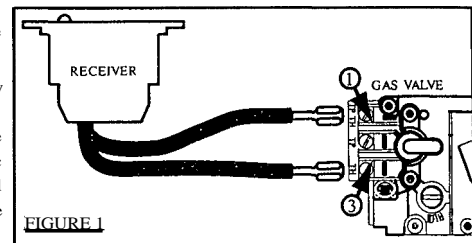

## RECEIVER WALL MOUNT

1.2 Press the battery compartment slightly into the receiver and release enabling the battery compartment to pop out. Pull off the slide switch. Slide the receiver out of the appliance mounting plate. **FIGURE 2**

1.3 Using the screws provided secure the receiver to an existing junction box, then secure the wall face plate to the receiver. **FIGURE 2**

1.4 Replace the black slide switch with the white one included to match the cover plate. Place 4 AA batteries into the battery compartment and slide the compartment back into the receiver. **FIGURE 3**

1.5 Turn on the electrical power and the gas supply to the appliance.

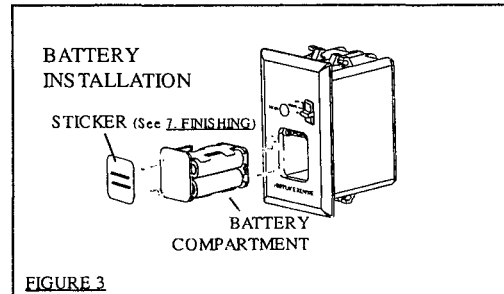
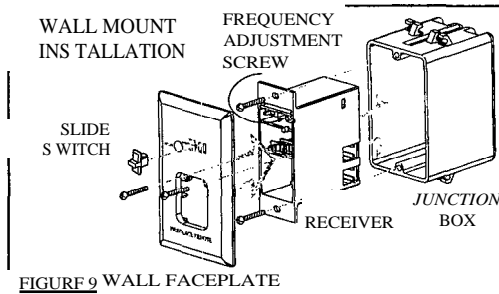

### @RECEIVER APPLIANCE MOUNT

For stove and insert models: Do not install the receiver in the gas control valve compartment in some models as this area becomes too hot. On stoves, it may be installed in or behind the pedestal; on inserts, it may be installed behind the flashings or a similar convenient location.

In a zero clearance model: The receiver may be installed in the gas control compartment located below the firebox with the exception of clean-faced models where access prohibits this location. See wall mount.

1.2 Ensuring that the mounting location will allow for the battery compartment to pop out, secure the receiver to an appropriate location depending on the appliance model using the adhesive pad located on the bottom of the appliance mounting plate.

1.3 Turn on the electrical power and the gas supply to the appliance.

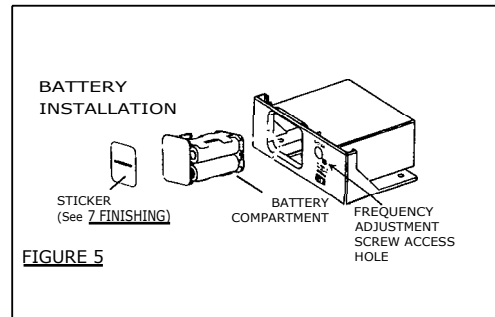
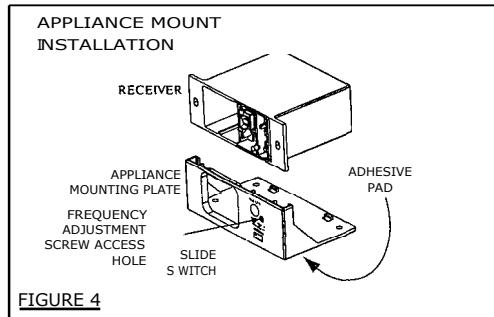

### 45 TRANSMITTER OPERATION

The 45 universal remote has been approved for use with most gas fireplaces, stoves, and inserts using a millivolt system or electronic ignition system. The 45 provides on/off status, the current room temperature as well as having low battery indicator and child-proof features. The 45 allows you to switch the appliance on or off from anywhere in the room.

This transmitter kit is tested and safe when installed in accordance with these instructions.

#### 2. COMMUNICATION BETWEEN THE TRANSMITTER AND RECEIVER:

2.1 Place 2 "AAA" batteries into the battery compartment of the transmitter. **FIGURE 6**

2.2 Place 4 "AA" batteries into the battery compartment of the receiver. **FIGURE 7**

2.3 Slide the switch on the receiver to the "REMOTE" position. The low battery indicator on the receiver will flash and the receiver will beep twice. The receiver is now ready to communicate with the transmitter.

You only have 30 seconds after the receiver is put in the "REMOTE" position to capture the code, which will be indicated by three beeps from the receiver.

2.4 Point the transmitter at the receiver, push and hold the "ON" button for 1 to 2 seconds to capture a pre-determined code.

2.5 The low battery indicator on the receiver will flash and the receiver will beep three times to confirm synchronization with the transmitter. At this time the remote should be fully operational.

#### 2.6 Troubleshooting

The transmitter display says "ON" but the appliance is not on. Turn the transmitter to "OFF" and then back to "ON". Pushing the "ON" button too quickly will not allow the receiver to pick up the signal from the transmitter. The transmitter button must be held for 1 to 2 seconds. If the remote still fails to communicate with the receiver move closer to the receiver to ensure communication is not interrupted.

**NOTE:** To access the frequency adjustment screw in a wall mount installation, the wall face plate must be removed. The frequency adjustment screw has been factory set. If for any reason the communication isn't strong enough between the receiver and transmitter, you can turn the adjustment screw counter-clockwise to increase its strength or clockwise to decrease it. 1/4 turns are recommended.

#### 3. BATTERIES:

New batteries have a limited shelf life and depending upon their age, may need to be replaced after a short period of time. Batteries should be replaced at least every 6 months or when the low battery indicator is lit on the receiver or the transmitter LED. Use alkaline batteries only. Remember to change the batteries in both the receiver and the transmitter.

##### 3.1 TO CHANGE BATTERIES:

Receiver: Slide the switch to OFF. Press the battery compartment slightly into the receiver and release enabling the battery compartment to pop out. After removing the original batteries, wait at least 1 minute before replacing with fresh batteries (Follow the programming instructions previously stated)

##### **FIGURE 7**

Transmitter: Gently press and slide the battery cover from the rear surface of the transmitter. After removing the original batteries, wait at least 1 minute before replacing with fresh batteries. **FIGURE 6**

##### 3.2 IN THE EVENT OF A BATTERY FAILURE:

If the receiver batteries fail, the appliance will no longer turn on or off. To operate the appliance in the event of a battery failure, the slide switch located on the receiver may be switched to the "ON" position to operate the appliance. (Section 1)

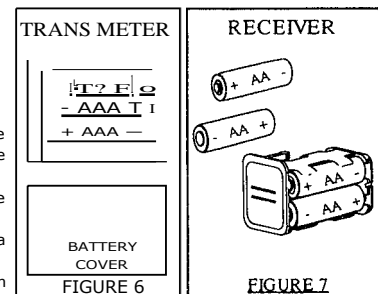

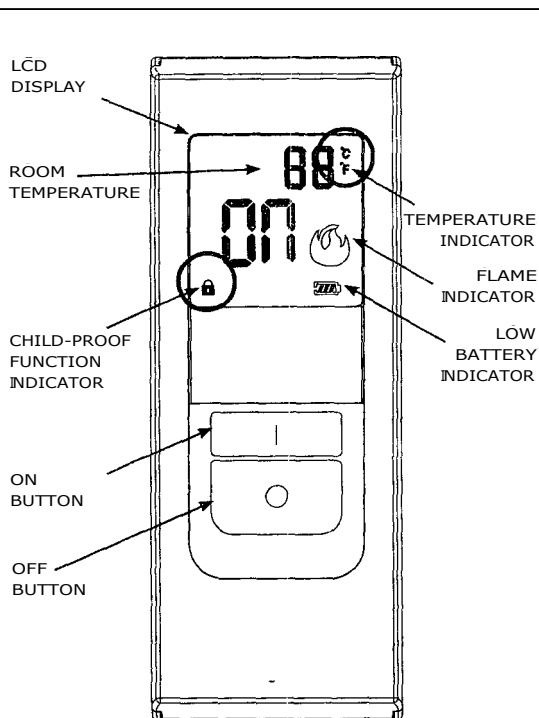

FIGURE 8

45

### 60 TRANSMITTER OPERATION

The 60 universal remote has been approved for use with most gas fireplaces, stoves, and inserts using a millivolt system or electronic ignition. The 60 is a thermostatically controlled transmitter that provides on/off status, displays room/set temperature as well as having low battery indicator and child-proof features.

This transmitter kit is tested and safe when installed in accordance with these instructions.

### 2. COMMUNICATION BETWEEN THE TRANSMITTER AND RECEIVER:

- 2.1 Place 2 "AAA" batteries into the battery compartment of the transmitter. **FIGURE 11**
- 2.2 Place 4 "AA" batteries into the battery compartment of the receiver. **FIGURE 12**
- 2.3 Slide the switch on the receiver to the "REMOTE" position. The low battery indicator on the receiver will flash and the receiver will beep twice. The receiver is now ready to communicate with the transmitter.
- 2.4 Point the transmitter at the receiver, push and hold the "ON" button for 1 to 2 seconds to capture a pre-determined code.

You only have 30 seconds after the receiver is put in the "REMOTE" position to capture the code, which will be indicated by three beeps from the receiver.

- 2.5 The low battery indicator on the receiver will flash and the receiver will beep three times to confirm synchronization with the transmitter. At this time the remote should be fully operational.

### 2.6 TROUBLESHOOTING

The transmitter display says "ON" but the appliance is not on. Turn the transmitter to "OFF" and then back to "ON". Pushing the "ON" button too quickly will not allow the receiver to pick up the signal from the transmitter. The transmitter button must be held for 1 to 2 seconds. If the remote still fails to communicate with the receiver move closer to the receiver to ensure communication is not interrupted.

### 3. BATTERIES:

New batteries have a limited shelf life and depending upon their age, may need to be replaced after a short period of time. Batteries should be replaced at least every 6 months or when the low battery indicator is lit on the receiver or the transmitter LCD. Use alkaline batteries only. Remember to change the batteries in both the receiver and the transmitter.

#### 3.1 TO CHANGE BATTERIES:

Receiver: Slide the switch to OFF. Press the battery compartment slightly into the receiver and release enabling the battery compartment to pop out. After removing the original batteries, wait at least 1 minute before replacing with fresh batteries. (Follow the programming instructions previously stated) **FIGURE 12**

Transmitter: Gently press and slide the battery cover from the rear surface of the transmitter. After removing the original batteries, wait at least 1 minute before replacing with fresh batteries **FIGURE 11**

#### 3.2 IN THE EVENT OF A BATTERY FAILURE:

If the receiver batteries fail, the appliance will no longer cycle on or off, remaining in the current operating mode. To operate the appliance in the event of a battery failure, the slide switch located on the receiver may be switched to the "ON" position to operate the appliance. (Section I)

- 3.3 If the transmitter batteries fail while in Thermostatic mode and there is no communication with the receiver, as a safety feature, the appliance will shut down after 12 hours and not function until batteries are replaced.

### 4. TRANSMITTER OPERATION:

The receiver switch must be in the REMOTE position for the transmitter to function. This remote system operates using radio frequency signals sent by the transmitter to the receiver. It is recommended that the distance between the transmitter and receiver never exceeds 20' and 10' if the receiver is located within the firebox shell. Low batteries will also affect operational distance.

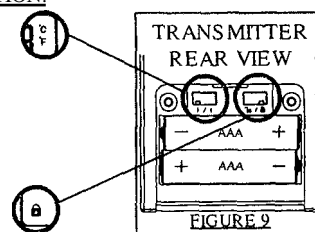

FIGURE 9

### 5. TEMPERATURE FUNCTION:

Remove the battery cover on the back of the transmitter to expose the °C/°F dip switch. Move the dip switch to your desired temperature mode. Selected temperature mode will appear in the top right corner beside the room temperature.

### 6. CHILD-PROOF FUNCTION:

- 6.1 Remove the battery cover at the back of the transmitter to expose the child-proof dip switch.
- 6.2 Slide the child-proof dip switch to the lock position to activate the child-proof function. A lock symbol will appear in the bottom left corner of the transmitter display when the child-proof function is activated.
- 6.3 In child-proof mode the transmitter will not operate the receiver until the switch is returned to the un-lock position however the receiver will continue operate in the thermostatic mode when locked.

FIGURE 10

UN-LOCK 13/a LOCK

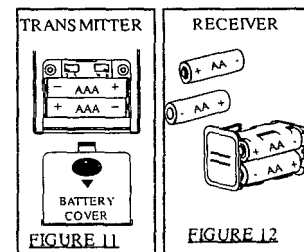

FIGURE 11

FIGURE 12

#### 4. TRANSMITTER OPERATION:

The receiver switch must be in the REMOTE position for the transmitter to function. This remote system operates using radio frequency signals sent by the transmitter to the receiver. It is recommended that the distance between the transmitter and receiver never exceeds 20' and 10' if the receiver is located within the fireplace's outer or inner cavity surrounding an insert. Low batteries will also affect operational distance.

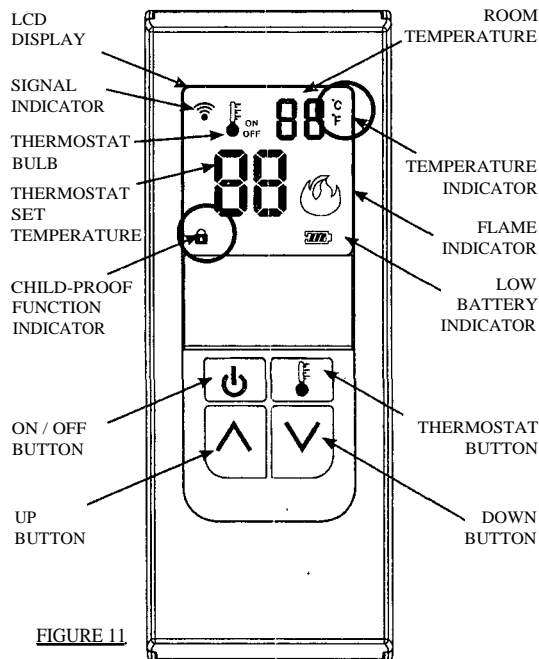

FIGURE 11

F60

#### 5. THERMOSTATIC FUNCTION:

Thermostatic control automatically cycles the appliance on and off to maintain the desired room temperature. When in thermostat mode, due to sensitive temperature monitoring components in the transmitter, it is important not to place the transmitter too close or too far from the appliance. Being too close will cycle the appliance on and off frequently, while being too far away may result in the appliance staying on for longer periods of time.

To turn the appliance burner on, press the **ON/OFF** button. The LCD will display the word 'ON' and the flame indicator will be shaded in.

The **ON/OFF** button is used to turn the appliance on or off only. It does not set temperature.

The **THERMOSTAT** button is used to control room temperature. Once pushed, 'ON' lights up next to the thermostat bulb located in the top left corner of the LCD screen.

Set desired room temperature using the **UP** and **DOWN** buttons.

If the temperature of the room exceeds or falls below the desired room temperature, the remote will automatically turn the appliance 'OFF' or 'ON'. To turn off thermostat mode, press **THERMOSTAT** button again.

**NOTE:** To reduce battery consumption, room temperature updates are made every 60 seconds.

When the transmitter batteries are exhausted or the transmitter is removed from the vicinity of the fireplace, the communication link will be broken. When in thermostatic mode, unless the batteries are replaced or the transmitter is returned, the fireplace will be shut off after 12 hours as a safety feature.

#### 6. THERMOSTATIC TEMPERATURE DIFFERENTIAL

In thermostatic mode there is a 1° temperature differential above and below the set temperature. This helps to cut back on the number of operational cycles. For example: if the set temperature is 20°, the appliance will turn on until the room temperature is 21°, then back off until the room temperature drops to 19°.

#### 7. TEMPERATURE FUNCTION:

Remove the battery cover on the back of the transmitter to expose the °C/°F dip switch. Move the dip switch to your desired temperature mode. Selected temperature mode will appear in the top right corner beside the room temperature.

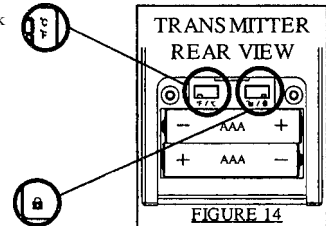

FIGURE 14

#### 8. CHILD-PROOF FUNCTION:

8.1 Remove the battery cover at the back of the transmitter to expose the child-proof dip switch.

8.2 Slide the child-proof dip switch to the lock position to activate the child-proof function. A lock symbol will appear in the bottom left corner of the transmitter display when the child-proof function is activated.

8.3 In child-proof mode the transmitter will not operate the receiver until the switch is returned to the un-lock position however the receiver will continue operate in the thermostatic mode when locked.

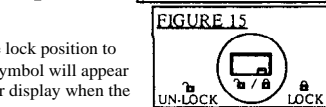

FIGURE 15

### 9. FINISHING:

Follow the diagram based on your receiver installation, wall mount or fireplace mount.

Remove the battery compartment from the receiver by pressing and releasing. Peel the self adhesive backing off the 'PRESS TO OPEN' sticker and affix to the front surface of the battery compartment. Replace the battery compartment into the receiver.

Secure the slide switch horizontally for the fireplace mounting plate and vertically for the wall faceplate.

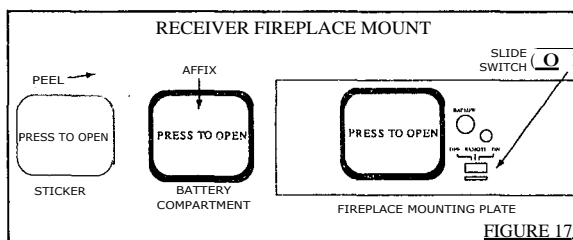
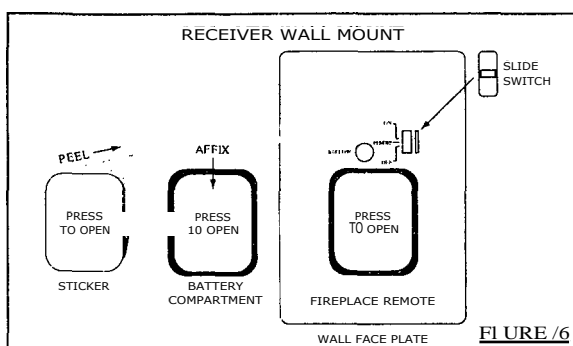

### 10. TRANSMITTER WALL MOUNT: (OPTIONAL)

Secure the wall cradle to the desired wall location using screws, and anchors if required. If wall mount is not desired wall cradle can be discarded.

FIGURE 18

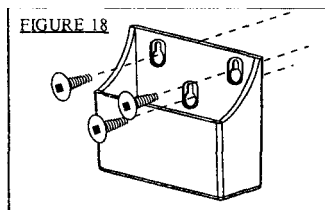

## . Awm\IN

1

### PROPERTY DAMAGE HAZARD.

EXCESSIVE HEAT CAN CAUSE PROPERTY DAMAGE.

The appliance can stay ignited for many hours. Take care to turn off the appliance if it is unattended by an adult.

### FIRE HAZARD. CAN CAUSE SEVERE INJURY OR DEATH.

The receiver causes the ignition of the appliance. The appliance can turn on suddenly. Keep away from the burner, especially when operating on the BACKUP switch.

Modification of any part of this kit will void any warranty claims and could create a fire hazard.

The transmitter and the receiver are radio frequency appliances. If the receiver is mounted inside metallic cases, severe loss of performance (reduction of working range) may result. When the receiver is installed inside the steel appliance shell, it is recommended that the transmitter be located no more than 10' away for consistent operation.

In the event of prolonged absences, the appliance installed with an 60 should not be left in thermostat mode or used as a primary heat source. Use a wall thermostat if required.

### FCC REQUIREMENTS:

Changes or modifications to this unit not expressly approved by the party responsible for compliance could void the user's authority to operate the equipment.

NOTE:; This equipment has been tested and found to comply with the limits for a Class B digital device, pursuant to Part 15 of the FCC Rules. These limits are designed to provide reasonable protection against harmful interference in a residential installation. This equipment generates, uses and can radiate radio frequency energy and, if not installed and used in accordance with the instructions, may cause harmful interference to radio communications. However, there is no guarantee that interference will not occur in a particular installation. If this equipment does cause harmful interference to radio or television reception, which can be determined by turning the equipment off and on, the user is encouraged to try to correct the interference by one or more of the following measures:

- Reorient or relocate the receiving antenna.
- Increase the separation between the equipment and receiver.

Consult the dealer or an experienced radio TV technician for help.

### CANADIAN EQUIPMENT REQUIREMENTS:

This digital apparatus does not exceed the (Class A / Class B) limits for radio noise emissions from digital apparatus set out in the Radio Interference Regulations of the Canadian Department of Communication. This device complies with RSS-210 of Industry and Science Canada. Operation is subject to the following two conditions: (1) this device may not cause interference, and (2) this device must accept any interference, including interference that may cause undesired operation of the device.

ISO  
9001-2008

W415-1026 /C /07.05.12