

Secure Temp[®] S2100 and ASHT

High-Temperature Factory-Built Chimneys



www.securitychimneys.com
800-361-4909 (US) 800-667-3387 (Canada)

Secure Temp® S2100

APPLICATIONS

The Secure Temp S2100 has been designed to widely exceed existing safety standards while offering the best available chimney system. It has been designed for use with wood, gas, oil, or coal-burning appliances. The Secure Temp S2100 high-temperature chimney is certified by Intertek Testing Services (Warnock Hersey) to ULC S629 standards for diameters of 6, 7 and 8 inches.

A TRADITION OF EXCELLENCE

For over 50 years, Security Chimneys has been an innovator in the venting field and a market leader in North America. Instrumental in the company's growth has been an ongoing focus on product improvement and the introduction of new, innovative products. This drive for excellence has given rise to the Secure Temp S2100, one of the most popular lines of venting products in North America. These high-quality products ensure that end-users benefit from maximum safety and proven corrosion protection.

INNOVATIVE COMPOSITION AND EASE OF INSTALLATION

The use of stainless steel, selected for its resistance to high temperatures and corrosion, lends outstanding durability to the Secure Temp S2100 high-temperature chimneys. Secure Temp S2100 has a temperature rating of 650°C (1200°F); max. continuous, 760°C (1400°F) brief forced fired; and 1150°C (2100°F) 3 x 30 minutes, tested.

All chimneys feature 2 inches (S2100) of superior-quality, high-density Secura Plus insulation. This exclusive insulation keeps the temperature of the outer casing relatively low, keeping safety features as simple as possible. The S2100, with 2 inches of insulation, is well-suited for outside installations in areas where very cold temperatures occur.

All Secure Temp S2100 high-temperature chimneys, regardless of diameter, can be installed as close as 2 inches from combustible materials.

The S2100 also features fast and easy Twist-Lock assembly. Lengths and universal fittings fit together and lock into place by twisting one-eighth of a turn. No other part is needed to ensure the chimney's structural stability, keeping installation time to a minimum.



SECURITY CHIMNEYS

SECURE TEMP 2100

CHIMNEYS FOR WOOD STOVE APPLICATIONS



Features	Benefits
Twist-Lock stainless steel coupler system with 1-inch overlap	<ul style="list-style-type: none"> • No screws or other attachments required • Fast and easy installation with one-eighth of a turn
Stainless steel inner lining	<ul style="list-style-type: none"> • Provides smoother surface • Little restriction of flue gases even with an elbow • Outstanding corrosion resistance
Two inches (S2100) of exclusive Secura Plus insulation	<ul style="list-style-type: none"> • No shifting of the insulation • Keeps cooling of gas temperatures minimal which stabilizes at high temperatures • Reduces condensation and creosote buildup • Increases appliance performance by providing stable draft • Low surface temperature • Minimum 2-inch safety clearance to combustible materials in all diameters
Fast venting of combustion products	<ul style="list-style-type: none"> • Delivers a stable and powerful draft
Stainless steel outer casing	<ul style="list-style-type: none"> • Supports the structural load • Corrosion resistance
Inner liner attached only to the male coupler	<ul style="list-style-type: none"> • Free-floating inner wall means no need for expansion joints • Unhindered expansion with rising temperatures
Lightweight - 6-inch diameter, 8.9lb per linear foot	<ul style="list-style-type: none"> • Delivers a more user-friendly design • For support, see "Loadbearing Capacity" chart on page 4.

INSTALLATION KEY

- 1 Black Stove Pipe
- 2 Finishing Cone
- 3 Insulated Wall Thimble
- 4 Tee Support
- 5 Insulated Tee
- 6 Insulated Length
- 7 Universal Wall Band
- 8 Insulated Attic Radiation Shield
- 9 Adjustable Roof Flashing w/ Storm Collar
- 10 Rain Cap
- 11 Firestop
- 12 Finishing Support
- 13 Anchor Plate

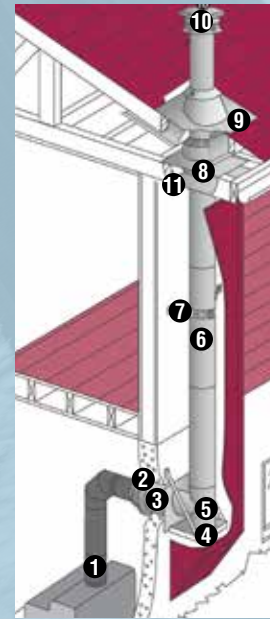

Exterior installation to a wood stove.

Offset and rise calculation

The following steps will help determine the lengths required for an installation:

1. Determine the offset required in view of the obstacles that must be avoided.
2. Refer to the "Offset/Rise Chart" to determine the elbows required as well as the insulated lengths needed.
3. Check the corresponding offset height dimensions.

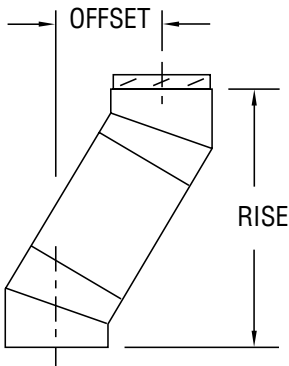

ELBOW OFFSET & RISE CHART

One length between elbows								
Angle	Dia.	8"	12"	18"	24"	36"	48"	
15	6" & 8"	Offset	3-5/16"	4-5/16"	5-7/8"	7-7/16"	10-1/2"	13-5/8"
		Rise	16"	19-7/8"	25-11/16"	31-1/2"	43-1/16"	54-5/8"
		Two lengths between elbows						
			8" & 48"	12" & 48"	18" & 48"	24" & 48"	36" & 48"	48" & 48"
		Offset	15-1/2"	16-1/2"	18-1/16"	19-5/8"	22-3/4"	25-13/16"
		Rise	61-7/16"	65-1/4"	71-1/16"	76-7/8"	88-1/2"	100-1/16"
30	6" & 8"	Offset	7-3/8"	9-3/8"	12-3/8"	15-3/8"	21-3/8"	27-3/8"
		Rise	20-11/16"	24-3/16"	29-3/8"	34-9/16"	44-15/16"	55-5/16"
		Two lengths between elbows						
			8" & 48"	12" & 48"	18" & 48"	24" & 48"	36" & 48"	48" & 48"
		Offset	30-7/8"	32-7/8"	35-7/8"	38-7/8"	44-7/8"	50-7/8"
		Rise	61-3/8"	64-7/8"	70-1/16"	75-1/4"	85-5/8"	96"
45	6" & 8"	Offset	10-5/16"	13-3/16"	17-3/8"	21-5/8"	30-1/8"	38-5/8"
		Rise	17-13/16"	20-5/8"	24-7/8"	29-1/8"	37-5/8"	46-1/8"
		Two lengths between elbows						
			8" & 48"	12" & 48"	18" & 48"	24" & 48"	36" & 48"	48" & 48"
		Offset	43-7/16"	46-1/4"	50-1/2"	54-3/4"	63-1/4"	71-11/16"
		Rise	50-15/16"	53-3/4"	58"	62-1/4"	70-3/4"	79-3/16"

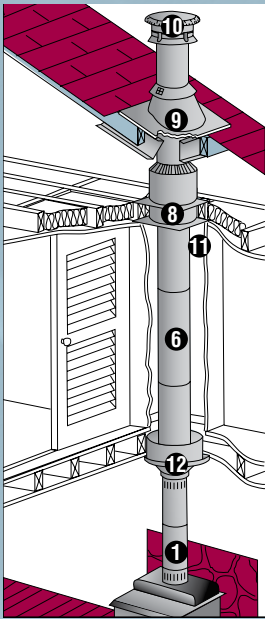

Interior installation on a wood stove using a finishing support.

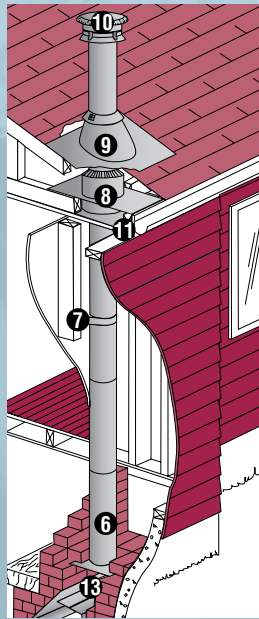

Chimney installed on a masonry fireplace.

Installation

Assembly always requires the male coupler to be positioned upwards. Size the chimney in accordance with the appliance instruction manual. Map out the chimney path closest to the heating unit. Prior to installation, consult the detailed installation manual included with the support components.

Any fireplaces and controlled combustion units can be connected to the Secure Temp S2100, since it has been certified, independently, to ULC S629M standards.

SAFETY

Security Chimneys Secure Temp S2100 chimneys can be installed as close as 2 inches to combustible materials, regardless of the diameter to be used. Radiation shields and appropriate supports must be used to maintain a safe clearance as the chimney passes through floors and combustible partitions.

LOADBEARING CAPACITY

Ø int.	Maximum height		
	6"	7"	8"
Wall support	30'	28'	26'
Adjust. wall/tee support	30'	28'	26'
Roof support	20'	18'	16'
Offset support	18'	16'	14'
Cathedral support	30'	28'	26'
Sq. cathedral support	30'	28'	26'
Finish support	30'	28'	26'
Offset/Wall support	24'	21'	20'
Reduced Clearance support	30'	28'	26'

SIZE OF OPENINGS*

Ø int.	Hole size (framing)		
	6"	7"	8"
Roof support	14"	15"	16"
Radiation shield	14"	15"	16"
Cathedral support	14-3/8"	14-3/8"	14-3/8"
Sq. cathedral support	14-3/8"	14-3/8"	14-3/8"
Finish support	14-3/8"	14-3/8"	14-3/8"
Reduced Clearance support	12"	13"	14"

Temperature Rating	Period of Operation
650° C (1200°F)	Max. continuous
760° C (1400°F)	Brief forced fired
1150° C (2100°F)	3 x 30 minutes, tested

SECURE TEMP S2100 GENERAL SPECIFICATIONS

Ø int.	Ø ext.	Insulation thickness	Weight lb./ft.*	Twist-Lock assembly	Clearance to combustible
6"	10"	2"	8.9	YES	2"
7"	11"	2"	9.9	YES	2"
8"	12"	2"	10.9	YES	2"

Secure Temp® ASHT

APPLICATIONS

The Secure Temp ASHT is one of the most extensively used factory-built venting systems in North America. It has been specially developed for use with oil and gas burning heating appliances and certified wood-burning fireplaces. The Secure Temp ASHT high-temperature chimney is certified by Intertek Testing (Warnock Hersey) to ULC S604 standards and ULC S610 (on wood-burning fireplaces) for all diameters of 5, 6, 7, 8 and 10 inches.

CERTIFICATION

The Secure Temp ASHT high-temperature chimney is certified by Intertek Testing (Warnock Hersey) to:

- ULC S604 standards for all diameters of 5, 6, 7, 8, and 10 inches.
- ULC S610 (on wood-burning fireplaces) for all diameters of 5, 6, 7, 8 and 10 inches.
- ULC S629 for wood stove applications in diameters of 6, 7, and 8 inches.

INSTALLATION

Assembly always requires the male coupler to be positioned upwards. Size the chimney in accordance with the appliance instruction manual. Map out the chimney path closest to the heating unit.

For wood stove applications, a third pipe (premium shield) is required for inside installation where the chimney is enclosed between two floors (see premium shield accessories section). Prior to installation, consult the detailed installation manual included with the support components.

SAFETY

Security Chimneys's Secure Temp ASHT chimneys can be installed as close as 2 inches to combustible materials, regardless of the diameter to be used. Radiation shields and appropriate supports must be used to maintain a safe clearance as the chimney passes through floors and combustible partitions.

Some radiation shields in the Secure Temp ASHT line have been designed specifically for use with wood-burning fireplaces. For the use of Secure Temp ASHT with manufactured wood fireplaces, refer to the instruction of these products.



SECURITY CHIMNEYS SECURE TEMP ASHT VENT SYSTEM FOR CHIMNEYS



1

Twist-Lock stainless steel coupler system with 1-inch overlap

- No screws or other attachments required
- Fast and easy installation with one-eighth of a turn

2

Stainless steel inner lining

- Provides smoother surface
- Little restriction of flue gases even with an elbow
- Outstanding corrosion resistance

3

One inch of exclusive Secura Plus insulation

- No shifting of the insulation
- Keeps cooling of gas temperature minimal, which stabilizes at high temperatures
- Reduces condensation and creosote buildup
- Low surface temperature
- Minimum 2-inch safety clearance to combustible materials in all diameters

4

Fast venting of combustion products

- Delivers a stable and powerful draft

4

Stainless steel outer casing

- Supports the structural load
- Corrosion resistance

5

Inner liner attached only to the male coupler

- Free-floating inner wall means no need for expansion joints
- Unhindered expansion with rising temperatures

6

Lightweight – 6-inch diameter, 5.2 lb. per linear foot

- Delivers a more user-friendly design
- For support, see "Loadbearing Capacity" chart on page 4.

7

INSTALLATION KEY

- 1 Insulated Elbow
- 2 Insulated Wall Radiation Shield
- 3 Insulated Length
- 4 Universal Offset Support
- 5 Insulated Attic Radiation Shield
- 6 Adj. Roof Flashing w/ Storm Collar
- 7 Rain Cap
- 8 Firestop
- 9 Connector
- 10 Base Tee for Twin Connections
- 11 Floor Support
- 12 Universal Roof Support
- 13 Flat Roof Flashing w/ Storm Collar
- 14 Black Stove Pipe
- 15 Finishing Support
- 16 Telescopic Rigid Shield
- 17 Radiation Shield Connector
- 18 Storm Collar
- 19 Radiation Shield Connector Firestop

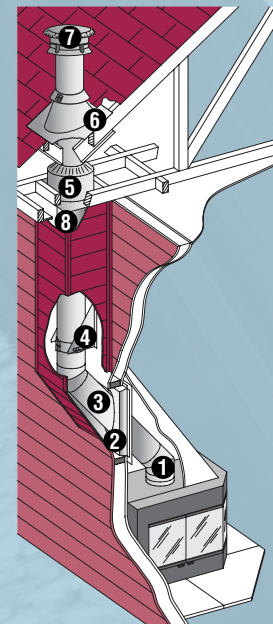

Fireplace through exterior insulated chase

Offset and rise calculation

The following steps will help determine the lengths required for an installation:

1. Determine the offset required in view of the obstacles that must be avoided.
2. Refer to the "Offset/Rise Chart" to determine the elbows required as well as the insulated lengths needed.
3. Check the corresponding offset height dimensions.

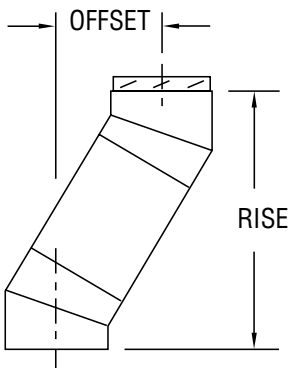

ELBOW OFFSET & RISE CHART

One length between elbows								
Angle	Dia.	8"	12"	18"	24"	36"	48"	
15	6" & 8"	Offset	3-5/16"	4-5/16"	5-7/8"	7-7/16"	10-1/2"	13-5/8"
		Rise	15-11/16"	19-9/16"	25-3/8"	31-3/16"	43-3/4"	54-3/8"
		Two lengths between elbows						
			8" & 48"	12" & 48"	18" & 48"	24" & 48"	36" & 48"	48" & 48"
		Offset	15-3/8"	16-7/16"	18"	19-1/2"	22-5/8"	25-3/4"
		Rise	60-15/16"	64-3/16"	70-9/16"	76-3/8"	87"	99-9/16"
30	6" & 8"	Offset	7-7/16"	9-7/16"	12-7/16"	15-7/16"	21-7/16"	27-7/16"
		Rise	20"	23-1/2"	28-11/16"	33-7/8"	44-1/4"	54-11/16"
		Two lengths between elbows						
			8" & 48"	12" & 48"	18" & 48"	24" & 48"	36" & 48"	48" & 48"
		Offset	30-13/16"	32-13/16"	35-13/16"	38-13/16"	44-13/16"	50-13/16"
		Rise	60-9/16"	64"	69-1/4"	74-7/16"	84-13/16"	95-1/4"
45	6" & 8"	Offset	10-5/16"	13-3/16"	17-3/8"	21-5/8"	30-1/8"	38-5/8"
		Rise	17-13/16"	20-5/8"	24-7/8"	29-1/8"	37-5/8"	46-1/8"
		Two lengths between elbows						
			8" & 48"	12" & 48"	18" & 48"	24" & 48"	36" & 48"	48" & 48"
		Offset	43-7/16"	46-1/4"	50-1/2"	54-3/4"	63-1/4"	71-11/16"
		Rise	50-15/16"	53-3/4"	58"	62-1/4"	70-3/4"	79-3/16"

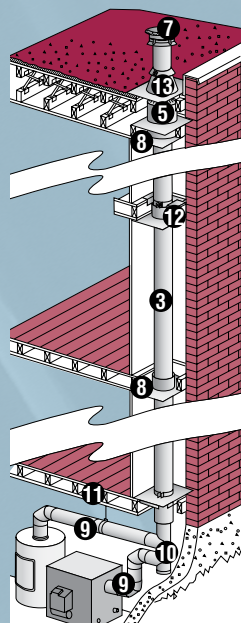

Residential furnace and water heater

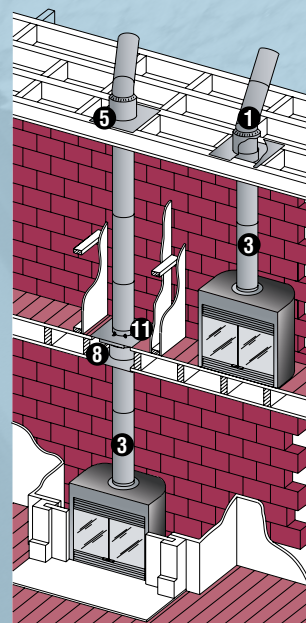

Chimney with several fireplaces

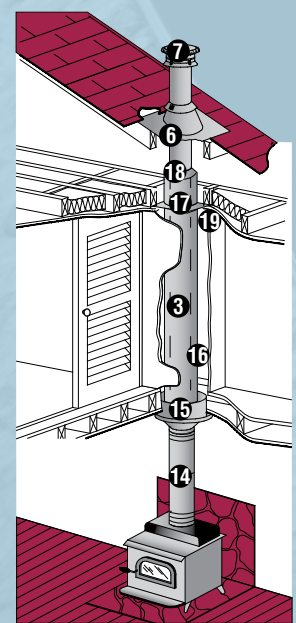

Chimney on a wood stove

Installation

Assembly always requires the male coupler to be positioned upwards. Size the chimney in accordance with the appliance instruction manual. Map out the chimney path closest to the heating unit. Prior to installation, consult the detailed installation manual included with the support components.

SAFETY

Security Chimneys International's Secure Temp ASHT chimneys can be installed as close as 2 inches to combustible materials, regardless of the diameter to be used. Radiation shields and appropriate supports must be used to maintain a safe clearance as the chimney passes through floors and combustible partitions.

Some radiation shields in the Secure Temp ASHT line have been designed specifically for use with wood-burning fireplaces. For the use of Secure Temp ASHT with manufactured wood fireplaces, refer to the instructions of these products.

LOADBEARING CAPACITY

Ø int.	Maximum height				
	5"	6"	7"	8"	10"
Floor support	32'	32'	32'	32'	32'
Tee support	63'	63'	55'	48'	39'
Adjust. tee/wall support	63'	63'	55'	48'	39'
Roof support	42'	34'	27'	24'	20'
Offset support	--	28'	24'	20'	14'
Sq. cathedral support	--	60'	50'	45'	35'
Finishing support	--	75'	65'	59'	--
Adj. square support w/ fanning arms and coupler	--	27'	22'	--	--
Offset/Wall support	--	28'	24'	20'	14'
Reduced Clearance support	--	60'	50'	45'	--

SIZE OF OPENINGS*

Ø int.	Hole size (framing)				
	5"	6"	7"	8"	10"
Floor support	11-3/8"	12-3/8"	13-3/8"	14-3/8"	16-3/8"
Tee support	11-3/8"	12-3/8"	13-3/8"	14-3/8"	16-3/8"
Sq. cathedral support	--	14-3/8"	14-3/8"	14-3/8"	--
Finishing support	14-3/8"	14-3/8"	14-3/8"	14-3/8"	--
Roof support	11-3/8"	12-3/8"	13-3/8"	14-3/8"	16-3/8"
Wall thimble	11-3/8"	12-3/8"	13-3/8"	14-3/8"	16-3/8"
Firestop	11-3/8"	12-3/8"	13-3/8"	14-3/8"	16-3/8"
Reduced Clearance support	--	10"	11"	12"	--
Temperature Rating		Period of Operation			
538°C (1000°F)		Max. continuous			
760°C (1400°F)		Brief forced fired			
1150°C (2100°F)		3 x 30 minutes, tested			

SECURE TEMP ASHT GENERAL SPECIFICATIONS

Ø int.	Ø ext.	Insulation thickness	Weight lb./ft.*	Twist-Lock assembly	Clearance to combustible
5"	7"	1"	4.1	YES	2"
6"	8"	1"	5.2	YES	2"
7"	9"	1"	6.4	YES	2"
8"	10"	1"	7.2	YES	2"
10"	12"	1"	8.9	YES	2"

Coding Logic:

This document contains a description of each of the parts for the Secure Temp ASHT and S2100 systems, as well as their respective applications. Each part has a reference letter that identifies the product.

The following examples of our coding system should make it easier for you to identify and order the components you need.

ASHT

Code	6L36	6FA
Size	6 Interior diameter	6 Interior diameter
Reference	L Insulated length	F Flashing
Specificity	36 36" length	A Adjustable

S2100

Code	6XL36	6XRSMI30
Size	6 Interior diameter	6 Interior diameter
Reference	XL Insulated length	XRS Radiation shield
Specificity	36 36" length	MI Insulated wall
		30 30° angle

Kits

Wall Support Kit for 6" & 7" Diameters

Kit includes:

Insulated tee, twist lock tee cap, adjustable tee support, insulated wall radiation shield, flue extension, double wall decorative collar, wall band, and rain cap.

Can use for through the wall installations.

Pipe not included.

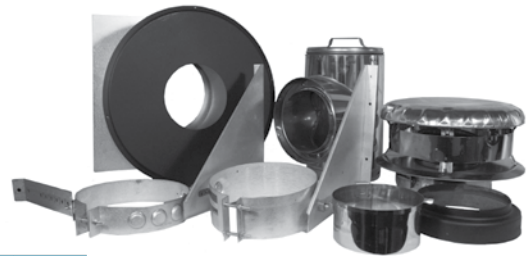

ASHT

Ref. 6WSK, 7WSK

Only available in 6" & 7" Diameters.

S2100

Ref. 6XWSK, 7XWSK

Only available in 6" & 7" Diameters.

Exterior Kit for 6" & 7" Diameters

Kit includes:

Insulated tee with insulated tee cap, adjustable tee support, insulated wall thimble, decorative collar single wall, flue extension, and decorative collar double wall, spark arrestor, rain cap, and wall band.

ASHT

Ref. 6EK-2, 7EK

Only available in 6" & 7" Diameters.

S2100

Ref. 6XKE, 7XKE

Only available in 6" & 7" Diameters.



Kits

Interior Kit

Kit includes:

Finishing support with coupler, 2 piece attic insulation shield, and rain cap.

Use for interior installations only.



ASHT

Ref. 6IK-1

Only available in 6" Diameter.

S2100

Ref. 6XKI, 7XKI

Only available in 6" Diameter.

Interior New Construction Kit

Kit includes:

Finishing support with removable outer trim collar, adjustable insulated attic radiation shield, and rain cap.

Use for new home construction with through the roof installation.



ASHT

Ref. 6IKNC

Only available in 6" Diameter.

Lengths

Insulated Lengths

ASHT: Five diameters and six standard effective lengths featuring a 1/8-turn Twist-Lock assembly.

S2100: Three diameters and six standard effective lengths featuring a 1/8-turn Twist-Lock assembly.

Various lengths may be combined to obtain the required installation height.

ASHT						S2100			
Ref. L						Ref. XL			
Ø int.	5"	6"	7"	8"	10"	Ø int.	6"	7"	8"
Ø ext.	7"	8"	9"	10"	12"	Ø ext.	10"	11"	12"
Lb./ft.	4.1	5.2	6.4	7.2	8.9	Lb./ft.	8.9	9.9	10.9
A	1-1/4"	1-1/4"	1-1/4"	1-1/4"	1-1/4"	A	1"	1"	1"

	Length Available	Effective Length
Ø 5 to 10	8"	6-3/4"
	12"	10-3/4"
	18"	16-3/4"
	24"	22-3/4"
	36"	34-3/4"
	48"	46-3/4"

	Length Available	Effective Length
Ø 6 to 8	8"	7"
	12"	11"
	18"	17"
	24"	23"
	36"	35"
	48"	47"

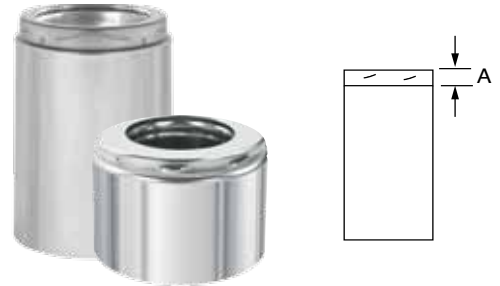

Adjustable Lengths

Used in combination with straight insulated lengths, the adjustable length makes it possible to fit a Secure Temp length perfectly. **IMPORTANT:** The adjustable length is not designed as a loadbearing component. Its vertical installation requires an appropriate support on the section above it to bear the weight of the remaining installation.

ASHT						S2100			
Ref. LA						Ref. XLA			
Ø int.	5"	6"	7"	8"	10"	Ø int.	6"	7"	8"
A	11-1/4"	11-1/4"	11-1/4"	11-1/4"	11-1/4"	A	11-1/4"	11-1/4"	11-1/4"

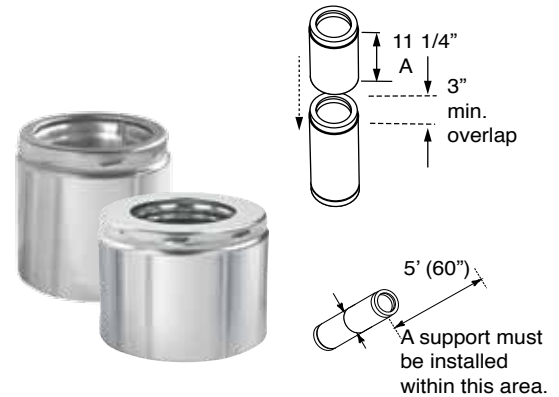

Elbows

15° Insulated Elbow

Allows the 15° offset of a chimney. Designed to bypass an obstacle, such as a joist. A maximum of two offsets (4 elbows) is allowed.

ASHT						S2100			
Ref. E15						Ref. XE15			
Ø int.	5"	6"	7"	8"	10"	Ø int.	6"	7"	8"
Ø ext.	7"	8"	9"	10"	12"	Ø ext.	10"	11"	12"
Lb./ft.	1/2"	1/2"	1/2"	1/2"	1/2"	A	5/8"	5/8"	5/8"
A	4-1/2"	4-1/2"	4-1/2"	4-1/2"	4-1/2"	B	4-3/4"	4-3/4"	4-3/4"

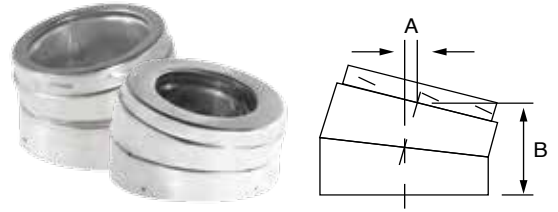

30° Insulated Elbow

Allows the 30° offset of a chimney. Designed to bypass an obstacle, such as a joist. A maximum of two offsets (4 elbows) is allowed.

ASHT						S2100			
Ref. E30						Ref. XE30			
Ø int.	5"	6"	7"	8"	10"	Ø int.	6"	7"	8"
Ø ext.	7"	8"	9"	10"	12"	Ø ext.	10"	11"	12"
Lb./ft.	2"	2"	2"	2"	2"	A	1-15/16"	1-15/16"	1-15/16"
A	7-1/2"	7-1/2"	7-1/2"	7-1/2"	7-1/2"	B	7-5/16"	7-5/16"	7-5/16"

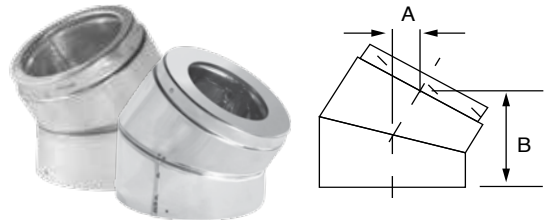

45° Insulated Elbow

Allows the 45° offset of a chimney. Designed to bypass an obstacle, such as a joist. A maximum of two offsets (4 elbows) is allowed. The chimney's angle of inclination must not deviate more than 45° from the vertical position.

ASHT						S2100			
Ref. E45						Ref. XE45			
Ø int.	5"	6"	7"	8"	10"	Ø int.	6"	7"	8"
Ø ext.	7"	8"	9"	10"	12"	Ø ext.	10"	11"	12"
Lb./ft.	3"	3"	3"	3"	3"	A	3"	3"	3"
A	6-7/8"	6-7/8"	6-7/8"	6-7/8"	6-7/8"	B	6-7/8"	6-7/8"	6-7/8"

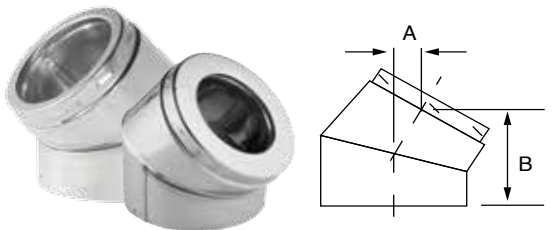

Tees

Base Tee

Located at the base of the chimney, it makes it possible to connect the chimney to a gas- or oil-burning appliance. It is recommended for interior installations only and must be attached to a flue extension. The galvanized steel base tee comes complete with a tee cap to provide access for inspection and cleaning. Available in stainless (TBS).

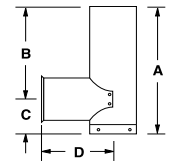

ASHT & S2100

Ref. TB or TBS

Ø int.	6"	7"	8"	10"
A	23"	24"	25"	27"
B	18"	18-1/2"	19"	20"
C	5"	5-1/2"	6"	7"
D	5-1/2"	6"	6-1/2"	7-1/2"

Double Base Tee

This component makes it possible to connect two appliances, such as a furnace and a water heater to the SecureTemp™ ASHT chimney. The galvanized steel base tee for twin connections comes with a tee cap (TC) to provide access for inspection and cleaning.

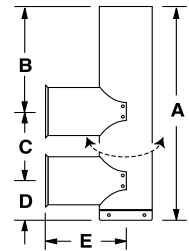

ASHT & S2100

Ref. TBD

Ø int.	6"	7"	8"	10"
A	31"	33"	35"	39"
B	18"	18-1/2"	19"	20"
C	5"	5-1/2"	6"	7"
D	5-1/2"	6"	6-1/2"	7-1/2"
E	8"	9"	10"	12"

Insulated Tee

Located at the base of the chimney, it provides the horizontal connection to the appliance. It is recommended for installations where a connector must pass through an exterior wall because its insulation prevents the cooling of chimney gases. An insulated tee cap (TCS) is included, which allows easy access for maintenance and inspection.

The insulated tee cap (TCS) must be secured to the flue extension of the tee support or adjustable tee support.

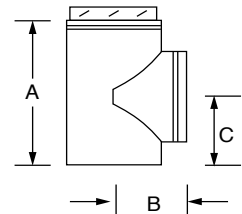

ASHT

Ref. TI

Ø int.	5"	6"	7"	8"	10"
Ø ext.	7"	8"	9"	10"	12"
A	9-1/2"	10-1/2"	11-3/4"	13"	15"
B	4-3/4"	5-1/4"	5-1/4"	6-1/4"	7-1/4"
C	5-1/2"	6"	6-1/2"	7-1/4"	8-1/4"

S2100

Ref. XTI

Ø int.	6"	7"	8"
Ø ext.	10"	11"	12"
A	13-1/4"	13-1/4"	13-1/4"
B	7"	7-1/2"	8"
C	7"	7-1/2"	8"

Tees

Insulated Tee Cap (Twist-Lock)

Equipped with a Twist-Lock system, it makes it possible to seal the base of an insulated tee when an adjustable wall support (SME or XSME) is used. It can be removed, providing easy access for chimney maintenance and inspection. Its insulation prevents the cooling of chimney gases, especially in exterior installations.

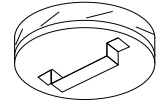

ASHT

Ref. TCI

Ø int.	5"	6"	7"	8"	10"
--------	----	----	----	----	-----

S2100

Ref. XTCl

Ø int.	6"	7"	8"
--------	----	----	----

Drain Tee Cap

Fitted at the base of an insulated tee, it makes it possible to collect and drain rainwater and condensates. The drain tee cap connects to a drain (NPT 0 1"). Removable, it provides easy access for chimney maintenance or inspection. Must be combined with an adjustable wall support only.



ASHT

Ref. TCP

Ø int.	6"	7"	8"	10"
--------	----	----	----	-----

Supports

Finishing Support

This part supports the chimney from a ceiling. Designed to connect to both double-wall and single-wall stove pipe, it is enhanced by a decorative black finish. Fits between standard 16"-on-center joists. Must be attached to a frame built from the joists. (Refer to chart on pg. 4 or 8 for loadbearing capacity and size of openings.) A finishing support is also available with a removable collar for 5" (5SFCA and 6" (6SFCA) installations.

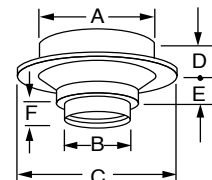

ASHT

Ref. SFC

Ø int.	5"	6"	7"	8"
A	12"	12"	14-3/8"	14-3/8"
B	5-1/4"	6-15/64"	7-1/4"	8-1/4"
C	20"	20"	20"	20"
D	5-1/2"	5-1/2"	5-1/2"	5-1/2"
E	3"	3"	3"	3"
F	2"	2"	2"	2"

S2100

Ref. XSFC

Ø int.	6"	7"	8"
A	14-3/8"	14-3/8"	14-3/8"
B	6-15/16"	7-1/4"	8-1/4"
C	20"	20"	20"
D	5-1/2"	5-1/2"	5-1/2"
E	3"	3"	3"
F	2"	2"	2"

Supports

Finishing Support with Removable Trim Collar

This part supports the chimney from a ceiling. Designed to connect to both double-wall and single-wall stove pipe, it is enhanced by a decorative black finish. Fits between standard 16"-on-center joists. Must be attached to a frame built from the joists. (Refer to chart on page 4 or 8 for loadbearing capacity and size of openings.) This finishing support has a removable trim collar for new construction installation.

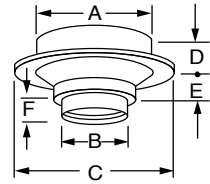

ASHT

Ref. SFCA

Ø int.	5"	6"
A	12"	12"
B	5-1/4"	6-15/64"
C	20"	20"
D	5-1/2"	5-1/2"
E	3"	3"
F	2"	2"

Round Cathedral Support

This part supports the chimney from a cathedral ceiling. Designed to connect the black stove pipe, it comes in a decorative black matte finish and must be attached to a frame built from the joists. (Refer to chart on pg. 4 or 8 for loadbearing capacity).

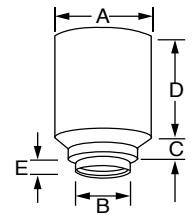

ASHT

Ref. SCC

Ø int.	6"	7"	8"
A	12"	14-3/8"	14-3/8"
B	6-1/4"	7-1/4"	8-1/4"
C	3"	3"	3"
D	13"	13"	13"

S2100

Ref. XSCC

Ø int.	6"	7"	8"
A	14-3/8"	14-3/8"	14-3/8"
B	6-1/4"	7-1/4"	8-1/4"
C	3"	3"	3"
D	13"	13"	13"

Insulated Reduced Clearance Support

Use with flat, vaulted or cathedral ceilings. Certified to reduce clearance to combustibles from the usual 2" (per side) down to a 1" (per side) for all diameters. This allows for a smaller hole to be cut in the ceiling. Can connect to both double-wall stove pipe or single-wall stove pipe with included adapter. Functions as both an Attic Insulation Shield and Finishing Support. An adjustable black finish trim insulation pad and collar are included. (Refer to chart on page 4 or 8 for loadbearing capacity).

ASHT

Ref. RCS

Ø int.	6"	7"	8"
A	6-15/64"	7-1/4"	8-1/4"
B	10"	11"	12"
C	24"	24"	24"
D	2"	2"	2"

S2100

Ref. XRCS

Ø int.	6"	7"	8"
A	6-1/4"	7-1/4"	8-1/4"
B	12"	13"	14"
C	24"	24"	24"
D	2"	2"	2"

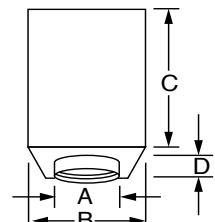

Supports

Reduced Clearance Support Extension

This part is designed to extend the height of the Insulated Reduced Clearance Support by 22" when the pitch of the roof is steep.

Fits all diameters.

ASHT

Ref. SE			
Ø int.	6"	7"	8"
A	10"	11"	12"
B	24"	24"	24"

S2100

Ref. XSE			
Ø int.	6"	7"	8"
A	12"	13"	14"
B	24"	24"	24"

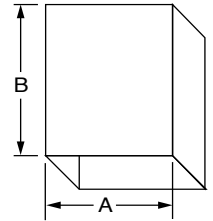

Square Cathedral Support 24"

This support is used with a chimney that is passing through an angled (cathedral) ceiling. Fits between standard 16"-on center joists. Designed to connect to both double-wall and single-wall stove pipe. An adjustable black finish trim is included. (Refer to chart on page 4 or 8 for loadbearing capacity).

ASHT

Ref. SSC24			
Ø int.	6"	7"	8"
A	6-15/64"	7-1/4"	8-1/4"
B	12"	14-3/8"	14-3/8"
C	24"	24"	24"
D	2"	2"	2"

S2100

Ref. XSSC24			
Ø int.	6"	7"	8"
A	6-1/4"	7-1/4"	8-1/4"
B	14-3/8"	14-3/8"	14-3/8"
C	24"	24"	24"
D	2"	2"	2"

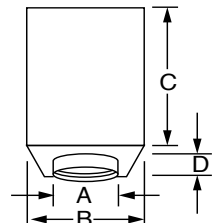

Supports

Square Cathedral Support Extension

This part is designed to extend the finish of the Square Cathedral Support when the pitch of the roof is steep. Must be attached to the Square Cathedral Support.

Fits all diameters.

ASHT & S2100

Ref. PS24

A	14-3/8"
B	24"

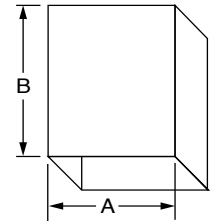

Adjustable Square Support, Black with Framing Arms

This part has the same use as the SFC or SSC, but has adjustable arms that extend to reach framing for support. It can be installed between 16"-on center joists with 2-1/2" of free play to eliminate the need for elbows. No framing is required.

ASHT

Ref. SSAC

Ø int.	5"	6"
A	12"	12"
B	17"	17"
C	5"	6"

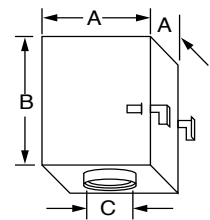

Tee Support

This part supports the chimney at the base of the installation. It is designed with a male coupler to accommodate the first section of the chimney. This tee support is made of galvanized steel and must be installed with the insulated tee cap (TCS) included with the insulated tee.

ASHT

Ref. SM

Ø int.	6"	7"	8"	10"
A	19"	19"	19"	16"
B	13"	13"	13"	16"
C	16"	16"	16"	16"

S2100

Ref. XSM

Ø int.	6"	7"	8"
A	18"	18"	18"
B	14-1/2"	16"	16"
C	16"	16"	16"

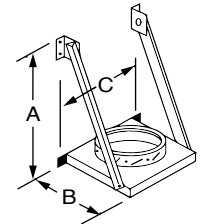

Supports

Adjustable Tee Support

This part supports the chimney at the base of the installation, functioning similarly to the tee support (SM) but with an adjustable base to provide additional wall clearance as needed. This tee support must be installed with the insulated tee cap (TCS) included with the insulated tee.

ASHT						S2100			
Ref. SMA						Ref. XSMA			
Ø int.	5"	6"	7"	8"	10"	Ø int.	6"	7"	8"
A	11-1/2"	11-1/2"	15-1/2"	15-1/2"	15-1/2"	A	18"	18"	18"
B	15"	15"	15"	15"	15"	B	14-1/2"	16"	16"
C	26-3/4"	26-3/4"	26-3/4"	26-3/4"	26-3/4"	C	26-3/4"	26-3/4"	26-3/4"
D	0 to 5"	0 to 5"	0 to 5"	0 to 5"	0 to 5"	D	0 to 5"	0 to 5"	0 to 5"

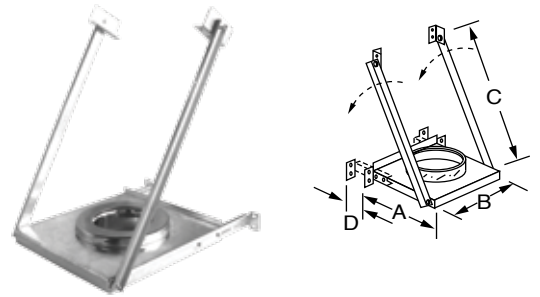

Adjustable Wall Support

This part supports the chimney at the base of the installation or along a wall or other vertical surface serving as an intermediate support. It comes with a tightening collar that locks around the chimney and is secured by two self-tapping screws (included).

The collar rests on a horizontal plate. When used as a base support, it lends itself to the addition of a Twist-Lock insulated tee cap (TI or XTCl). (Refer to the chart on pg. 4 or 8 for loadbearing capacity.)

ASHT						S2100			
Ref. SME						Ref. XSME			
Ø int.	5"	6"	7"	8"	10"	Ø int.	6"	7"	8"
A	13"	13"	13"	13"	16"	A	15-1/2"	15-1/2"	15-1/2"
B	16"	16"	16"	16"	16"	B	15"	15"	15"
C	26-3/4"	26-3/4"	26-3/4"	26-3/4"	26-3/4"	C	26-3/4"	26-3/4"	26-3/4"
D	0 to 5"	0 to 5"	0 to 5"	0 to 5"	0 to 5"	D	0 to 5"	0 to 5"	0 to 5"

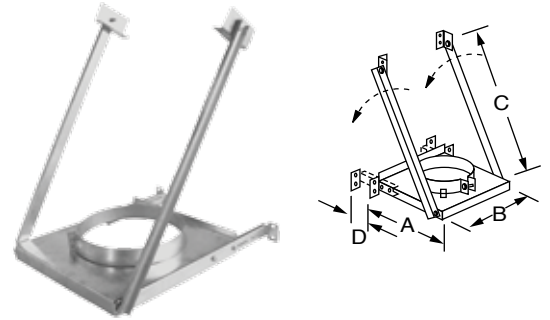

Supports

Universal Offset/Wall Support

This part is designed to support the chimney on a vertical wall. The triangular plates allow a 2" to 4" lateral adjustment of the support to the vertical surface. This support can also be used as a wall support above the insulated tee. When used as a tee support, it lends itself to the addition of a Twist-Lock insulated tee cap (TI or XTCL). (Refer to the chart on pg. 4 or 8 for loadbearing capacity.)

ASHT						S2100			
Ref. SO						Ref. XS0			
Ø int.	5"	6"	7"	8"	10"	Ø int.	6"	7"	8"
A	8-1/2"	9-1/2"	10-1/2"	11-1/2"	13-1/2"	A	11-1/2"	12-1/2"	13-1/2"
B	12"	12"	12"	12"	12"	B	12"	12"	12"
C	2-3/4"	2-3/4"	2-3/4"	2-3/4"	2-3/4"	C	2-3/4"	2-3/4"	2-3/4"
D	2"	2"	2"	2"	2"	D	2"	2"	2"

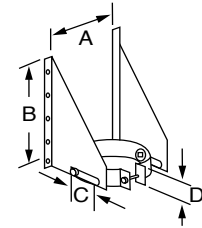
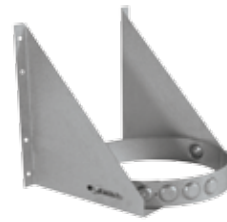

Wall Support

This part is designed to support the chimney on a vertical wall. The triangular plates allow a 2" to 6" lateral adjustment of the support to the vertical surface. When used as a tee support, it lends itself to the addition of a Twist-Lock insulated tee cap (TI or XTCL). (Refer to the chart on page 4 or 8 for loadbearing capacity.)

ASHT			S2100		
Ref. SO-1			Ref. XS0-1		
Ø int.	6"	7"	Ø int.	6"	7"
A	9-1/2"	10-1/2"	A	11-1/2"	12-1/2"
B	11-1/2"	11-1/2"	B	11-1/2"	11-1/2"
C	4"	4"	C	4"	4"
D	3"	3"	D	3"	3"

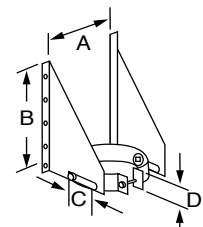
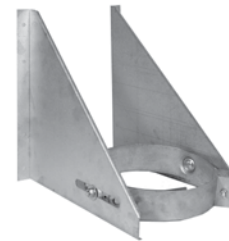

Universal Roof Support

This complementary support is usually attached to a roof structure. It is designed to support the chimney:

- from the roof, adjusting to any roof pitch
- above an offset
- when the chimney height exceeds the loadbearing capacity of the primary support.

Two adjustable plates screwed to the structure adapt to the pitch of the roof. A tightening collar is attached and locks around the chimney. It is secured by self-tapping screws. (Refer to the chart on pg. 4 or 8 for loadbearing capacity.)

ASHT						S2100			
Ref. ST						Ref. XST			
Ø int.	5"	6"	7"	8"	10"	Ø int.	6"	7"	8"
A	8"	8"	8"	8"	8"	A	8"	8"	8"
B	4"	4"	4"	4"	4"	B	4"	4"	4"
C	2"	2"	2"	2"	2"	C	2"	2"	2"

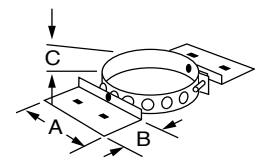

Supports

Floor Support

Used mainly from a basement, this part supports the chimney on a slab, floor, or joist and also acts as a firestop. It makes it possible to maintain a 2" clearance between the chimney's outer casing and combustible materials in its path. It includes a tightening collar that locks around the chimney and is secure by self-tapping screws (included). The collar rests on a horizontal plate screwed or nailed to the floor or slab. It can also serve as an intermediate support. (Refer to the chart on pg. 4 or 8 for load-bearing capacity.)

ASHT

Ref. SD					
Ø int.	5"	6"	7"	8"	10"
A	7"	8"	9"	10"	12"
B	11"	12"	13"	14"	20"
C	16"	16"	16"	18"	18"

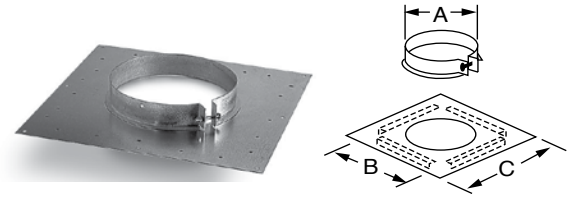

Anchor Plate

This part is attached to a masonry or metal-casing fireplace to provide a proper connection to the chimney. It can also serve to connect a furnace. (Refer to the chart on pg. 4 or 8 for loadbearing capacity.)

ASHT

Ref. SP					
Ø int.	5"	6"	7"	8"	10"
A	5"	6"	7"	8"	10"
B	12"	12"	12"	12"	14"
C	2"	2"	2"	2"	2"
D	3"	3"	3"	3"	3"

S2100

Ref. XSP			
Ø int.	6"	7"	8"
A	6"	7"	8"
B	14"	14"	14"
C	2"	2"	2"
D	3"	3"	3"

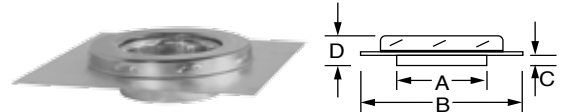

Flue Extension

Fitted to the base of the first chimney length, this component makes it possible to extend the inner casing, thereby facilitating the attachment of the stove pipe or other type of connector. It can also be attached directly to the appliance outlet as a chimney adapter. The crimped end of this component is slightly tapered for easier assembly.

ASHT & S2100

Ref. UP					
Ø int.	5"	6"	7"	8"	10"
A	3"	3"	3"	3"	3"
B	5"	6"	7"	8"	10"

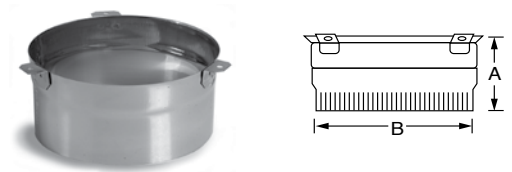

Premium Shield Accessories

Swivel Adaptor

Designed for use as an option to ease the connection in tight spaces between the flexible shield and the radiation shield connector (SRS)

ASHT

Ref. ASP

∅ int.	6"	7"	8"
A ext.	10-19/32"	11-19/32"	12-19/32"
B ext.	10-11/16"	11-11/16"	12-11/16"

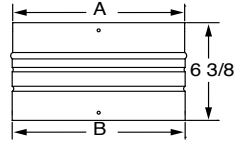

Telescopic Rigid Shield

Used as a casing shield around the chimney only where it is enclosed inside a building (for example, between floors or in a chase). It attaches with screws to a radiation shield connector at each floor/ceiling.

ASHT

Ref. TRS

∅ int.	6"	7"	8"
--------	----	----	----

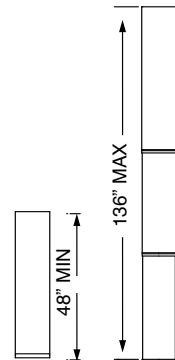

Flexible Shield

Designed for use in the same applications as a rigid shield where an offset is required.

ASHT

Ref. FS

∅ int.	6"	7"	8"
A ext.	10-19/32"	11-19/32"	12-19/32"
B ext.	10-11/16"	11-11/16"	12-11/16"

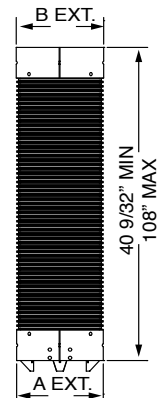

Premium Shield Accessories

Radiation Shield Connector (Insulated)

Used in conjunction with a radiation shield connector support (RSSR) or firestop (RCSP) where the enclosed chimney passes through a ceiling/floor. It attaches to the chimney using 4 screws through brackets. A storm collar must be used at the top in an attic installation.

ASHT

Ref. SRS				
Ø int.	6"	7"	8"	
A ext.	10-13/32"	11-13/32"	12-13/32"	

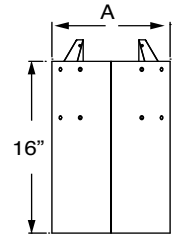

Radiation Shield Connector Firestop

W

ASHT

Ref. RCSP				
Ø int.	6"	7"	8"	
A	16"	16"	16"	
B	12"	13"	14"	
C	10-21/32"	11-21/32"	12-21/32"	

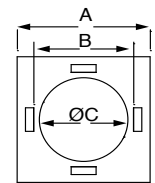

Radiation Shield Connector Support

Used in conjunction with a radiation shield connector (SRS) on floors where the chimney needs to be supported (for example, after an offset).

ASHT

Ref. RSSR				
Ø int.	6"	7"	8"	
A ext.	10-17/32"	11-17/32"	12-17/32"	
B ext.	15"	16"	17"	

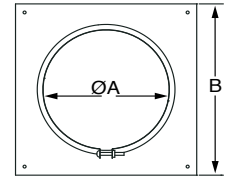

Shield Accessories

Radiation Shield

Protects combustible materials when the chimney passes through a floor or an intermediate ceiling. It ensures a 2" safety clearance between the chimney's outer casing and surrounding combustibles. When passing through a ceiling, it is to be installed from the underside of the ceiling. (Required in some jurisdictions in replacement of the firestop.)

ASHT					
Ref. RS					
Ø int.	5"	6"	7"	8"	10"
A	16"	16"	16"	16"	16"
B	10"	11"	12"	13"	15"
C	10"	10"	10"	10"	10"

S2100			
Ref. XRS			
Ø int.	6"	7"	8"
A	16"	18"	18"
B	13"	14"	15"
C	10"	10"	10"

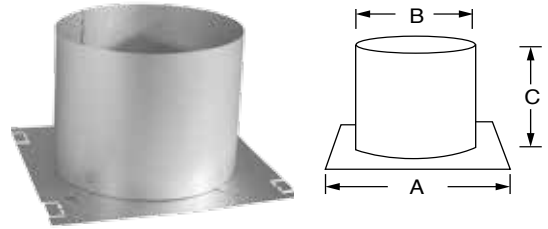

Two-Piece Insulated Attic Radiation Shield

Also referred to as an insulation shield, it protects combustible materials when a chimney passes through an attic. It is imperative that it be installed overside from the attic. Its cone shape keeps insulation from seeping between the outer casing and the firestop. It also maintains a 2" clearance from combustible materials. Insulated to prevent cold air intrusion. Storm collar included.

ASHT					
Ref. RSA2					
Ø int.	5"	6"	7"	8"	10"
A	11"	12"	13"	14"	16"
B	11"	12"	13"	14"	16"
C	12"	12"	12"	12"	12"
D	16"	16"	16"	16"	18"

S2100			
Ref. XRSA2			
Ø int.	6"	7"	8"
A	14"	15"	16"
B	14"	15"	16"
C	12"	12"	12"
D	16"	18"	18"

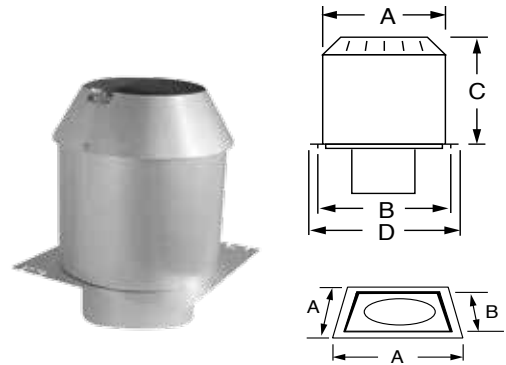

Adjustable Insulated Attic Radiation Shield

Also referred to as an insulation shield, this has the same features as the two-piece insulated attic radiation shield but its height is adjustable from 12" to 22". Insulated to prevent cold air intrusion. Storm collar included.

ASHT					
Ref. ARSA					
Ø int.	5"	6"	7"	8"	10"
A	11"	12"	13"	14"	16"
B	11"	12"	13"	14"	16"
C	16"	16"	16"	16"	16"

S2100			
Ref. XARSA			
Ø int.	6"	7"	8"
A	14"	15"	16"
B	14"	15"	16"
C	16"	18"	18"

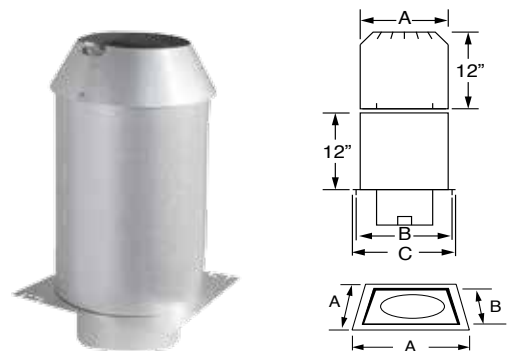

Insulated Radiation Shield

Designed for use with wood-burning stoves or fireplaces certified for use with the SecureTemp ASHT or S2100 chimneys, it should be used where the chimney passes through a ceiling or exterior opening where insulation is required. It must be used in combination with an attic radiation shield when passing through an attic. Recommended for use in cold regions.

ASHT			
Ref. RSI			
Ø int.	7"	8"	10"
A	16"	16"	18"
B	3"	3"	3"
C	13"	13"	15"

S2100		
Ref. XRSI		
Ø int.	7"	8"
A	18"	18"
B	3"	3"
C	14"	14"

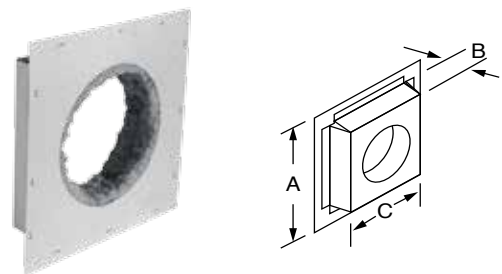

Shield Accessories

Insulated Wall Thimble

Designed to protect surrounding combustible materials when a chimney crosses through a wall horizontally, this shield can be adjusted from 7" to 12-1/2" to adapt to the thickness of the wall opening. A decorative plate painted in matte black provides an interior finish. Insulated to prevent cold air intrusion.

ASHT						S2100			
Ref. RSM						Ref. XRSM			
∅ int.	5"	6"	7"	8"	10"	∅ int.	6"	7"	8"
A	17"	17"	20"	20"	20"	A	20"	20"	20"
B	7-1/4"	8-1/4"	9-1/4"	10-1/4"	12-1/4"	B	10-3/8"	11-3/8"	12-3/8"
C	← 7-1/2" to 12-1/2" →					C	← 7" to 12-1/2" →		
D	14"	16"	16"	16"	18"	D	16"	16"	18"
E	11"	12"	13"	14"	16"	E	14"	15"	16"

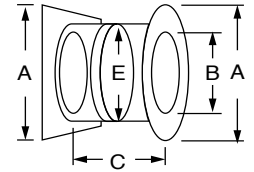

30° & 45° Insulated Wall Radiation Shield

This part is to be used only with the Security wood-burning fireplace line and others that have been certified for use with the chimney. It has been designed for use when the chimney passes through a wall at an angle.

ASHT					S2100			
Ref. RSMI30					Ref. XRSMI30			
∅ int.	6"	7"	8"	10"	∅ int.	6"	7"	8"
A	36-3/4"	39-1/4"	41-1/4"	44-13/16"	A	38-3/4"	40-3/4"	42-13/16"
B	17-1/8"	18-1/8"	19-1/8"	20-1/8"	B	16-7/8"	17-7/8"	18-7/8"
C	15-1/8"	16-1/8"	17-1/8"	18-1/8"	C	18-7/8"	19-7/8"	20-7/8"
D	34-3/4"	37-1/4"	39-1/4"	42-13/16"	D	40-11/16"	42-3/4"	44-13/16"
E	3"	3"	3"	3"	E	3"	3"	3"

ASHT					S2100			
Ref. RSMI45					Ref. XRSMI45			
∅ int.	6"	7"	8"	10"	∅ int.	6"	7"	8"
A	26-11/32"	18-1/8"	19-1/2"	32"	A	27-1/2"	28-5/8"	30"
B	17-1/8"	18-1/8"	19-1/8"	20-1/8"	B	17-1/8"	17-7/8"	18-7/8"
C	15-1/8"	16-1/8"	17-1/8"	18-1/8"	C	19-1/8"	19-7/8"	20-7/8"
D	24-3/8"	26-1/8"	27-1/2"	30"	D	29-1/2"	30-3/8"	32"
E	3"	3"	3"	3"	E	3"	3"	3"

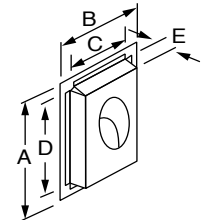

Shield Accessories

Angled Firestop 30° & 45°

This angled firestop is to be used only with the Security wood-burning fireplace line and others that have been certified for use with the chimney.

ASHT					S2100			
Ref. RSM30					Ref. XRSM30			
Ø int.	6"	7"	8"	10"	Ø int.	6"	7"	8"
A	15-3/8"	16-5/8"	17-5/8"	19-3/8"	A	17-3/8"	18-3/8"	19-3/8"
B	35-1/4"	37-3/4"	39-3/4"	43-5/16"	B	39-1/4"	41-1/4"	43-5/16"
C	13-5/16"	14-9/16"	15-9/16"	17-3/8"	C	15-5/16"	16-5/16"	17-1/16"

Ref. RSM45				
Ø int.	6"	7"	8"	10"
A	15-5/8"	16-5/8"	17-5/8"	19-5/8"
B	24-7/8"	26-5/8"	28"	30-1/2"
C	9-15/16"	10-13/16"	11-1/2"	12-3/4"

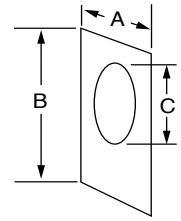
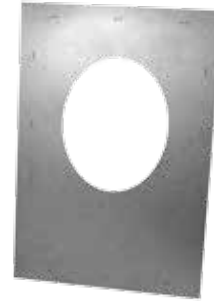

Firestop

Designed for use below each combustible floor the chimney passes through.

ASHT					S2100				
Ref. BF					Ref. XBF				
Ø int.	5"	6"	7"	8"	10"	Ø int.	6"	7"	8"
A	14"	16"	16"	16"	18"	A	16"	18"	18"
B	11"	12"	13"	14"	16"	B	14"	15"	16"

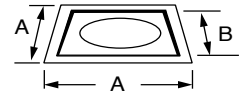
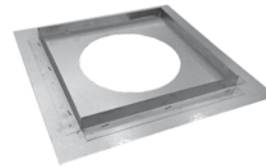

Universal Wall Band

Designed for use on an interior or exterior wall, it serves to stabilize the chimney while providing the required clearance from the combustible surface. The use of wall bands at maximum intervals of 8' is recommended. Also available in 6" fix configuration (6BM)

ASHT					S2100				
Ref. BM					Ref. XBM				
Ø int.	5"	6"	7"	8"	10"	Ø int.	6"	7"	8"
A	7"	8"	9"	10"	12"	A	10"	11"	12"
B	19"	21"	23"	25"	29"	B	25"	27"	29"
C	2"	2"	2"	2"	2"	C	2"	2"	2"

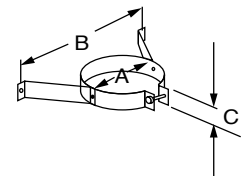

Universal Roof Brace

Designed to stabilize a chimney extending from 60" to 115" beyond the roof, or when a chimney is exposed to high winds. This part is supplied with tightening collar and adjustable legs.

ASHT					S2100				
Ref. BS2					Ref. XBS2				
Ø int.	5"	6"	7"	8"	10"	Ø int.	6"	7"	8"
A	7"	8"	9"	10"	12"	A	10"	11"	12"
B	← 60" to 115" →					B	← 60" to 115" →		

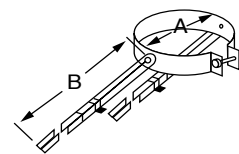

Shield Accessories

Guy Wire Band

Attached to the outer casing of the chimney (secured by bolts), it is designed to hold 3 guy wires. It is recommended for chimneys exceeding the roof by 5' to 13' maximum. Wire not included.

ASHT

Ref. BH				
Ø int.	6"	7"	8"	10"
A	2"	2"	2"	2"

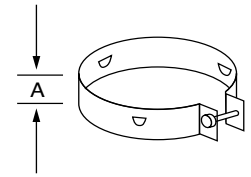

Flashings

Flat Roof Flashing

This component seals a chimney length when passing through a flat roof and comes complete with a storm collar.

ASHT

Ref. F					
Ø int.	5"	6"	7"	8"	10"
A	7-1/2"	7-1/2"	7-1/2"	7-1/2"	7-1/2"
B	20"	24"	24"	24"	24"

S2100

Ref. XF			
Ø int.	6"	7"	8"
A	7-1/2"	7-1/2"	7-1/2"
B	24"	24"	24"

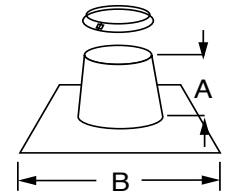
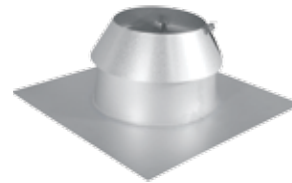

Peak Roof Flashing

This component is required for chimney installations passing through the roof peak. It is available in two models:

- Peak roof: 1/12 to 7/12 FP/XFP
- Peak roof: 8/12 to 12/12 FPB/XFPB

ASHT

Ref. FP/FPB				
Ø int.	6"	7"	8"	10"
Ref. FPR				
A	3-5/8"	3-5/8"	3-5/8"	3-5/8"
B	12"	13"	13-1/2"	15"
Ref. FPBR				
A	5"	4"	3-1/4"	1-1/2"
B	14"	14"	14"	14"

S2100

Ref. XFP/XFPB			
Ø int.	6"	7"	8"
Ref. XFP			
A	3-5/8"	3-5/8"	3-5/8"
B	13-1/2"	14"	15"
Ref. XFPB			
A	3-1/2"	3-1/2"	3-1/2"
B	14"	14"	14"

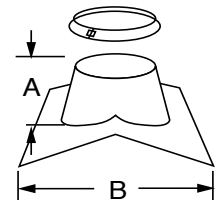

Flashings

Adjustable Roof Flashing*

This part is required to accommodate sloped roof installations. Available in five versions to adapt to the needs of the following roof slopes:

- 1/12 to 7/12 pitch: FA/XFA
- 8/12 to 12/12 pitch: FB/XFB
- 12/12 to 21/12 pitch: FBB/XFBB

Also available in aluminum malleable base plate (Ref. FAA, FBA)

ASHT						S2100				
Ref. FA/FB/FBB/FAA/FBA						Ref. XFA/XFB/XFBB				
Ø int.	5"	6"	7"	8"	10"	Ø int.	6"	7"	8"	
Ref. FA						Ref. XFA				
A	6"	6"	6"	6"	6"	A	6"	6"	6"	
B	24"	24"	24"	24"	24"	B	24"	24"	28"	
Ref. FB						Ref. XFB				
A	6"	6"	4-3/8"	3-7/8"	3-7/8"	A	3-7/8"	3-7/8"	4-1/2"	
B	24"	24"	24"	24"	30"	B	24"	24"	30"	
Ref. FBB						Ref. XFBB				
A	--	6-1/4"	6-1/4"	6-1/4"	6-1/4"	A	6-1/4"	6-1/4"	6-1/4"	
B	--	36"	36"	36"	42"	B	36"	40"	42"	
Ref. FAA										
A	--	6"	6"	6"	--					
B	--	36"	36"	36"	--					
Ref. FBA										
A	--	6"	6-3/8"	6-7/8"	--					
B	--	36"	36"	36"	--					

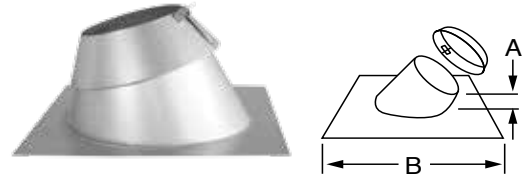

Storm Collar

Designed to fit over flashings, it provides a weather-tight seal. It is automatically supplied with any roof flashings.

ASHT						S2100				
Ref. FC						Ref. XFC				
Ø int.	5"	6"	7"	8"	10"	Ø int.	6"	7"	8"	
A	5"	5"	5"	5"	5"	A	5"	5"	5"	

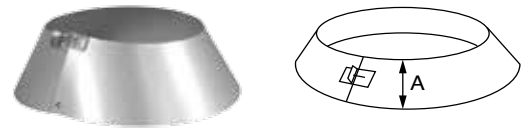

Snow Diverter

Use to divert snow around chimney, vent and roof flashing.. Bendable attachment flanges allow it to mount on any roof slope. Constructed of paintable galvanized material. Ships flat for easy assembly.

ASHT & S2100	
Ref. FSD	
Universal piece fits all diameters	

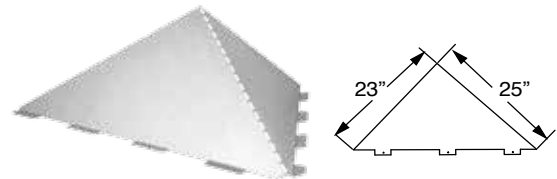

Rain Cap

Rain Cap

Attached to the top of the chimney, it effectively prevents rain, snow and leaves from entering the opening. Check local codes to determine if a spark arrester (PE) is required.

ASHT & S2100

Ref. CC

Ø int.	5"	6"	7"	8"	10"
A	4"	4"	4"	4-3/4"	4-3/4"
B	12-1/4"	12-1/4"	12-1/4"	15-1/2"	15-1/2"

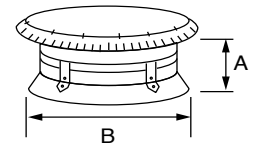

Spark Arrester Band

This spark arrester band is wrapped around the rain cap, preventing sparks from falling onto the roof or animals from entering into the chimney.

ASHT & S2100

Ref. PE

Universal piece fits all diameters.



Decorative Accessories

Decorative Trim

The use of this decorative trim provides a flawless finish when a chimney must pass through a ceiling or any wall.

ASHT

Ref. PF

Ø int.	8"	9"	10"
Ø Ext.	17"	20"	20"

S2100

Ref. XPF

Ø int.	8"	9"	10"
Ø ext.	20"	20"	20"

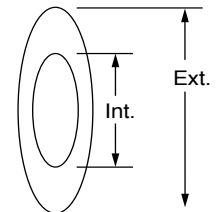

Decorative Collar Single-Wall

This component provides a finish between the Secure Temp chimney's female coupler and single-wall stove pipe. Note: For double-wall stove pipe connection, see our "DL" catalog section.

ASHT

Ref. PB

Ø int.	6"	7"	8"
A	8"	9"	10"
B	6"	7"	8"
C	1"	1"	1"

S2100

Ref. XPB

Ø int.	6"	7"	8"
A	10"	11"	12"
B	6"	7"	8"
C	1"	1"	1"

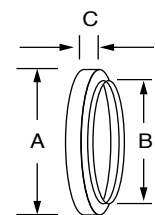

Decorative Accessories

Black Pipe Adaptor

This component is recommended for connecting a standard black pipe to the Secure Temp chimney when a longer extension length is required. A finishing collar is supplied.

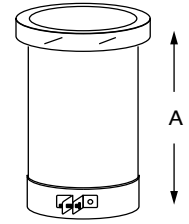

ASHT

Ref. PA

Ø int.	6"	7"	8"
A	12"	12"	12"

S2100

Ref. XPA

Ø int.	6"	7"	8"
A	12"	12"	12"

Finishing Cone

When the chimney passes through an exterior wall, a finishing cone may be used to conceal the protrusion of the insulated length (5") inside the dwelling. A flue extension must be used to ensure a perfect connection between the chimney and the double-wall black connector.

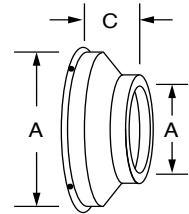

ASHT & S2100

Ref. PD

Ø int.	6"	7"	8"
A	14-3/8"	14-3/8"	14-3/8"
B	6-1/4"	7-1/4"	8-1/4"
C	5-1/2"	5-1/2"	5-1/2"

Limited Lifetime Warranty

This Security Chimneys International, Ltd. (SCIL) Limited Lifetime Warranty warrants your residential vent and/or chimney system to be free from defects in material and workmanship at the time of manufacture. This Limited Lifetime Warranty includes all components and fittings, except termination caps and Secure Black SW single wall black stove pipe. After installation, if covered components manufactured by SCIL are found to be defective in materials or workmanship during the Limited Lifetime Warranty period and while the Product remains at the site of the original installation, SCIL will, at its option, replace the covered components. SCIL reserves the right to replace covered components with an equivalent product and the replacement must be carried out in accordance with SCIL's recommendations. If replacement is not commercially practical, SCIL will, at its option, refund the purchase price or wholesale price of the SCIL product, whichever is applicable. THERE ARE EXCLUSIONS AND LIMITATIONS to this Limited Lifetime Warranty as described herein.

COVERAGE COMMENCEMENT DATE

Warranty coverage begins on the date of installation. In the case of new home construction, warranty coverage begins on the date of first occupancy of the dwelling or six months after the sale of the Product by an independent SCIL dealer/distributor, whichever occurs earlier. The warranty shall commence no later than 24 months following the date of product shipment from SCIL, regardless of the installation or occupancy date.

EXCLUSIONS AND LIMITATIONS

This Limited Lifetime Warranty applies only if the Product is installed in the United States or Canada and only if used for the application for which it was designed and intended. The Product must be maintained in accordance with the printed instructions accompanying the Product and in compliance with all applicable installation and building codes and good trade practices.

This warranty is transferable. The Product must be purchased through a listed supplier of SCIL and proof of purchase must be provided. SCIL will be responsible for the replacement of the residential vent and/or chimney system considered to be defective for the following periods:

Termination Caps & Secure Black SW Stove Pipe – Replacement at no charge for 5 years from the date of installation, excluding labor

Components and fittings (excludes termination caps and Secure Black SW) –

Year 1-15 – Replacement of all components and fittings (a labor allowance may apply to a maximum of 300 \$ * certain conditions apply).

Year 16 – Replacement at 50% off of the prevailing list price in effect at the time of replacement (No labor allowance applies).

*Labor Allowance Conditions: Any Warranty replacement work must be performed by a Professional Installer.

SCIL will not be responsible for: (a) damages caused by normal wear and tear, corrosion from salt air, accident, riot, fire, flood or acts of God; (b) damages caused by abuse, negligence, misuse, or unauthorized alteration or repair of the Product affecting its stability or performance. (The Product must be subject to normal use with approved fuels listed in the Operation Manual provided with the product. Where applicable, fuel products with abnormal burning characteristics, including but not limited to fuel such as driftwood, plywood and wood products using a binder may burn at excessive temperatures and may cause damage to the Product or may cause it to function improperly; (c) damages caused by failing to provide proper maintenance and service in accordance with the instructions provided with the Product; (d) damages, repairs or inefficiency resulting from faulty installation or application of the Product.

This Limited Lifetime Warranty covers only parts as provided herein. SCIL's entire liability is limited to the purchase price of this product. In no case shall SCIL be responsible for materials, components or construction which are not manufactured or supplied by SCIL or for the labor necessary to install, repair or remove such materials, components or construction. Additional utility bills incurred due to any malfunction or defect in equipment are not covered by this Limited Lifetime Warranty. All replacement or repair components will be shipped F.O.B. from the nearest stocking SCIL factory.

LIMITATION ON LIABILITY

It is expressly agreed and understood that SCIL's sole obligation and the purchaser's exclusive remedy under this warranty, under any other warranty, expressed or implied, or in contract, tort or otherwise, shall be limited to replacement, repair, or refund, as specified herein.

In no event shall SCIL be liable for any incidental or consequential damages caused by defects in the Product, whether such damage occurs or is discovered before or after replacement or repair, and whether such damage is caused by SCIL's negligence. SCIL has not made and does not make any representation or warranty of fitness for a particular use or purpose, and there is no implied condition of fitness for a particular use or purpose. SCIL makes no expressed warranties except as stated in this Limited Lifetime Warranty. The duration of any implied warranty is limited to the duration of this expressed warranty.

No one is authorized to change this Limited Lifetime Warranty or to create for SCIL any other obligation or liability in connection with the Product. Some states and provinces do not allow the exclusion or limitation of incidental or consequential damages, so the above limitations or exclusions may not apply to you. The provisions of this Limited Lifetime Warranty are in addition to and not a modification of or subtraction from any statutory warranties and other rights and remedies provided by law.

INVESTIGATION OF CLAIMS AGAINST WARRANTY

SCIL reserves the right to investigate any and all claims against this Limited Lifetime Warranty and to decide, in its sole discretion, upon the method of settlement.

To receive the benefits and advantages described in this Limited Lifetime Warranty, the appliance must be installed and repaired by a licensed contractor approved by SCIL. Contact SCIL at the address provided herein to obtain a listing of approved dealers/distributors. SCIL shall in no event be responsible for any warranty work done by a contractor that is not approved without first obtaining SCIL's prior written consent.

HOW TO REGISTER A CLAIM AGAINST WARRANTY

In order for any claim under this warranty to be valid, you must contact the SCIL dealer/distributor from which you purchased the product. If you cannot locate the dealer/distributor, then you must notify SCIL in writing. SCIL must be notified of the claimed defect in writing within 90 days of the date of failure. Notices should be directed to the SCIL Warranty Department at 2125 Monterey, Laval, Quebec, Canada H7L 3T6.

www.securitychimneys.com

Security Chimneys

2125 Monterey, Laval, Quebec
Canada, H7L 3T6

450-973-9999

800-361-4909 (US)

800-667-3387 (Canada)

450-973-2222 (Fax)

Need product information or technical support? Our customer service specialists are ready to answer your questions:

800-667-3387 or contact

infoeng@securitychimneys.com



EASHT/S2100
LS304_Catalog_Secure Temp ASHT _S2100_07-20-17_V2
www.securitychimneys.com **800-361-4909 (US)** **800-667-3387 (Canada)**

Security Chimneys International © 2015, 2017

Information published in all Security Chimneys literature is current at time of publication and is subject to change without notice.